

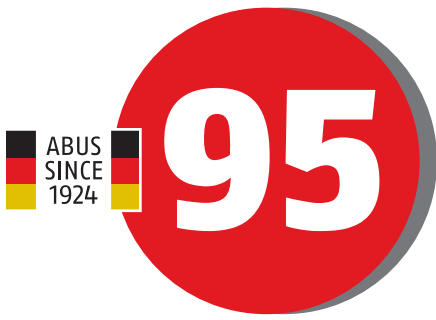

Security Tech Germany



2019 SECURITY CATALOG



YEARS
OF INNOVATION
Family-owned since 1924

COST SAVINGS \$

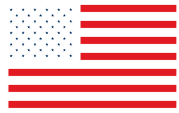

ABUS USA ★ PHOENIX, ARIZONA
UNITED STATES HEADQUARTERS AND WAREHOUSE

WHY ABUS?



FAMILY OWNED

FLEXIBLE
MOST STOCK ORDERS SHIP IN
48 HOURS



IN-HOUSE LASER ENGRAVING



NO JOB IS TOO SMALL

LARGEST PORTFOLIO OF PADLOCKS IN THE WORLD



GLOBAL IMPACT



3,000 EMPLOYEES
19 BRANCH OFFICES
106 INTERNATIONAL OUTLETS

DEDICATED ACCOUNT REPRESENTATIVES



CHARTING & KEY STAMPING AVAILABLE



FREE FREIGHT ON ORDERS \$750+

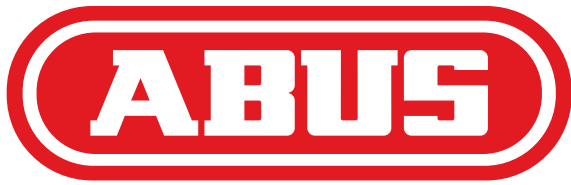

Security Tech Germany

Customer Support

Do you have a question concerning ABUS, but don't know who to contact? We're here to help, and you can contact us in the following ways:

- Call us at 800-352-ABUS to speak to a Customer Support representative from 7:00 a.m. to 4:00 p.m. Mountain Standard Time.
- Email us at customerservice@us.abus.com.
- Visit www.abus.com to learn more about ABUS products and services.

FIND US @ABUSUSA!



THE OFFICIAL LOCK OF THE PHOENIX SUNS

Padlocks	4	Padlocks
Hasps	34	Hasps
Accessories	37	Accessories
Vitess™ High Security	41	Vitess™ High Security
General Information	51	General Information
		3

HIGH SECURITY DISKUS® 20



- Original Diskus® design: 360° protection
- 100% non-corrosive stainless steel inside and out
- Diskus® Deep-Welding Technology provides maximum strength and pry resistance
- Shackle made from stainless steel
- Anti-cut plate
- ABUS-Plus disk cylinder: highest protection against manipulation, extremely high number of key differs, drilling and pulling protected

Item	Shackle Height	Pins in Cylinder	Key Options	Case Pk Qty
20/70 B	43/64" "	6	KD, KA, MK	6
20/80 B	45/64" "	6	KD, KA, MK	3



WEATHERPROOF DISKUS® 24IB



- Original Diskus® design: 360° protection
- 100% non-corrosive: shackle and all inner components made of stainless steel
- Diskus® Deep-Welding Technology provides maximum strength and pry resistance
- Precision pin cylinder - extra plated for ultimate corrosion resistance

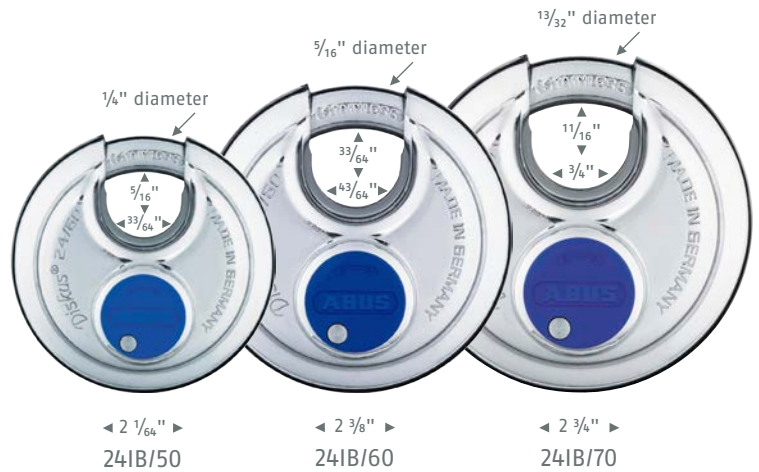

Item	Shackle Height	Pins in Cylinder	Key Options	Case Pk Qty
24IB/50 B	5/16"	4	KD, KA	6
24IB/60 C	33/64"	4	KD, KA	6
24IB/60 B	33/64"	4	KD, KA, MK	6
24IB/70 C	11/16"	5	KD	6
24IB/70 B	11/16"	5	KD, KA, MK	6



DIMPLE-KEY DISKUS® 25

STAINLESS STEEL DISKUS® 26

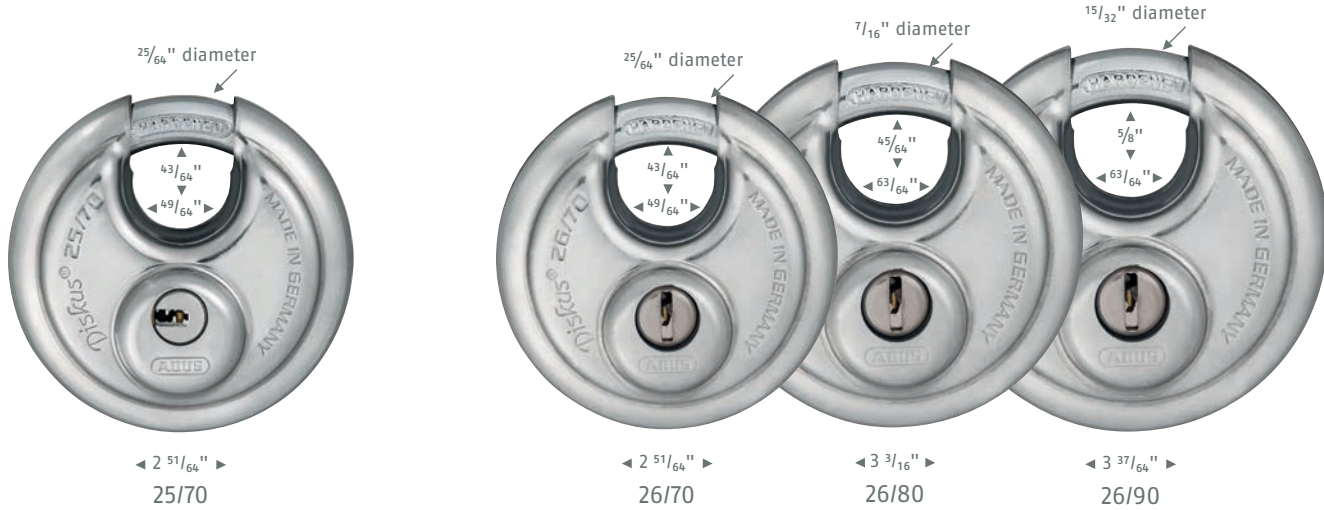

- High precision reversible key with 8,000 key differs
- Spare keys can only be ordered with assigned code
- 100% non-corrosive stainless steel inside and out
- Shackle made from hardened steel
- Original Diskus® design: 360° protection
- Anti-cut plate
- Diskus® Deep-Welding Technology provides maximum strength and pry resistance
- Key retaining: lock retains key until locked

- 100% non-corrosive stainless steel inside and out
- Massive inner base for enhanced security
- Anti-cut plate
- Shackle made from special alloy hardened steel
- Precision pin cylinder, drilling and pulling protected
- Diskus® Deep-Welding Technology provides maximum strength and pry resistance
- Original Diskus® design: 360° protection
- Key retaining: lock retains key until locked

Item	Shackle Height	Pins in Cylinder	Key Options	Case Pk Qty
25/70 B	43/64"	8	KD	6

Item	Shackle Height	Pins in Cylinder	Key Options	Case Pk Qty
26/70 B	43/64"	5	KD, KA, MK	6
26/80 B	45/64"	6	KD, KA, MK	3
26/90 B	5/8"	6	KD, KA, MK	3



For easy ordering, call 800.352.ABUS, fax 623.516.9934 or email customerservice@us.abus.com | abus.com

HARDENED STEEL DISKUS® 28

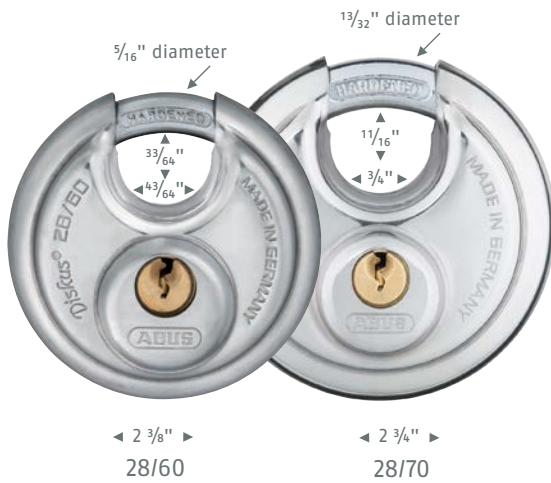

- Original Diskus® design: 360° protection
- Diskus® Deep-Welding Technology provides maximum strength and pry resistance
- Shackle made from hardened steel
- Precision pin cylinder with anti-pick pins

Item	Shackle Height	Pins in Cylinder	Key Options	Case Pk Qty
28/60 B	$\frac{33}{64}$ "	4	KD, KA	6
28/70 C	$\frac{11}{16}$ "	5	KD	6
28/70 B	$\frac{11}{16}$ "	5	KD, KA	6



GRANIT™ 37[RK]/55

37ST/55



37/55, 37/55HB50, 37/55HB75

- Shackle and body made from hardened alloy steel
- ABUS-Plus disk cylinder, highest protection against manipulation, high number of key differs
- Black Granit™ coating for high corrosion resistance
- Cylinder can be rekeyed to match an existing key
- 2 keys, 1 with LED light



37ST/55

- Body and shackle made of stainless steel
- Inner parts made of non-corrosive materials
- ABUS-PLUS disk cylinder, highest protection against manipulation, high number of key differs
- Cylinder inserts from the top: optimum drill and pull resistance
- 2 keys, 1 with LED light

Item	Shackle Height	Pins in Cylinder	Key Options	Case Pk Qty
37RK/55 B	1 3/64"	7	KD, KA, MK	3
37/55 B	1 3/64"	7	KD	1
37/55HB50 B	2"	7	KD, KA, MK	3
37/55HB75 B	3"	7	KD, KA, MK	4

Item	Shackle Height	Pins in Cylinder	Key Options	Case Pk Qty
37/55 ST-C	1 3/64"	7	KD	2

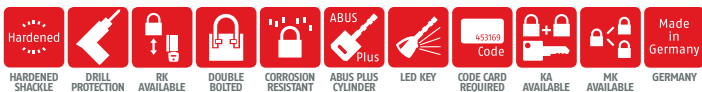

For easy ordering, call 800.352.ABUS, fax 623.516.9934 or email customerservice@us.abus.com | abus.com

GRANIT™ 37RK/70

37[RK]/60, 80



- Body and shackle made from hardened alloy steel
- ABUS-Plus disk cylinder, highest protection against manipulation, high number of key differs
- Cylinder inserted from the top: optimum drill and pull resistance
- Black Granit™ coating for high corrosion resistance
- Cylinder can be rekeyed to match an existing key
- 2 keys, 1 with LED light

- Body and shackle made from hardened alloy steel
- ABUS-Plus disk cylinder, highest protection against manipulation, high number of key differs
- Cylinder inserted from the top: optimum drill and pull resistance (37RK/80)
- Shackle guard protects shackle from attacks
- Black Granit™ coating for high corrosion resistance
- Cylinder can be rekeyed to match an existing key
- 2 keys, 1 with LED light

Item	Shackle Height	Pins in Cylinder	Key Options	Case Pk Qty
37RK/70 B	1 3/8"	7	KD, KA, MK	1

Item	Shackle Height	Pins in Cylinder	Key Options	Case Pk Qty
37RK/60 B	5/8"	7	KD	1
37/60 B	5/8"	7	KD	1
37RK/80 B	55/64"	7	KD, KA, MK	1



For easy ordering, call 800.352.ABUS, fax 623.516.9934 or email customerservice@us.abus.com | abus.com



LAMINATED STEEL 41

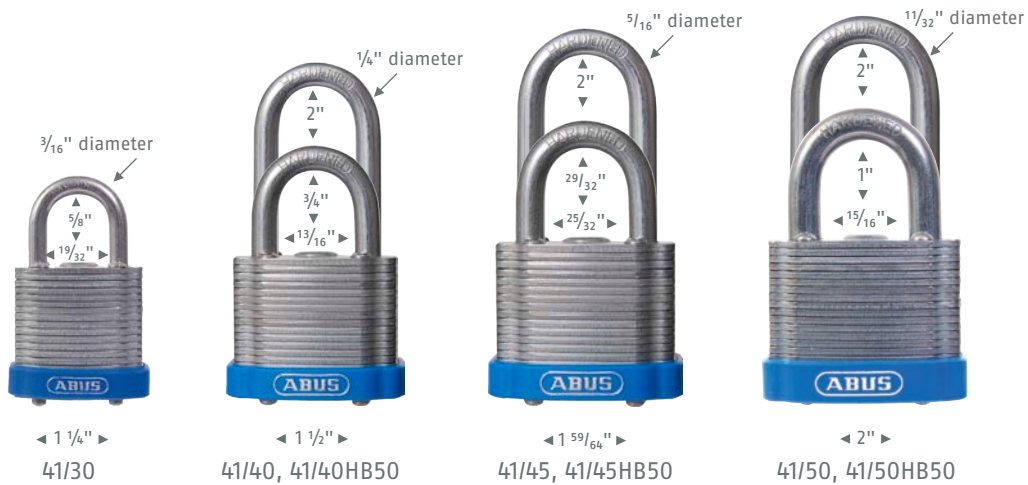

- Laminated steel with ETERNA™ coating on each laminate for extreme corrosion resistance
- ETERNA™: Non-hazardous, cadmium-free plating
- Tough, countersunk rivets
- Hardened steel shackle
- High-precision 5-pin tumbler, drilling and pulling protected
- Plastic bumper for easy identification

Item	Shackle Height	Pins in Cylinder	Key Options	Case Pk Qty
41/30 B	5/8"	4 or 5	KD, KA, MK	4
41/40 C	3/4"	4 or 5	KD	6
41/40 B	3/4"	4 or 5	KD, KA, MK	6
41/40HB50 B	2"	4 or 5	KD, KA, MK	6
41/45 B	29/32"	4 or 5	KD	6
41/45HB50 B	2"	4 or 5	KD, KA, MK	6
41/50 C	1"	4 or 5	KD	6
41/50 B	1"	4 or 5	KD, KA, MK	6
41/50HB50 B	2"	4 or 5	KD, KA	6



For easy ordering, call 800.352.ABUS, fax 623.516.9934 or email customerservice@us.abus.com | abus.com

LAMINATED STEEL 45

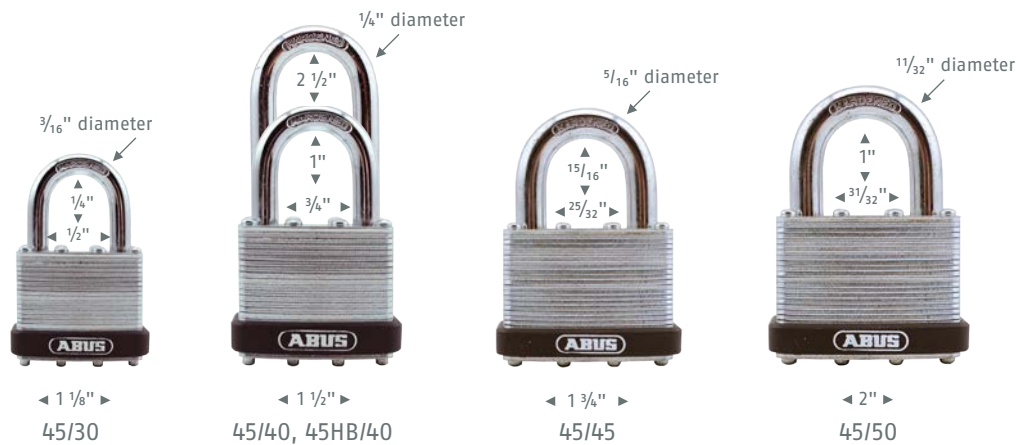

- Laminated steel, individually galvanized
- Hardened steel shackle, difficult to cut
- Tough steel rivets
- Cylinder protected against drilling and pulling

Item	Shackle Height	Pins in Cylinder	Key Options	Case Pk Qty
45/30 C	1/4"	4	KD	6
45/40 C	1"	4	KD	6
45HB/40 C	2 1/2"	4	KD	6
45/45 C	15/16"	4	KD	6
45/50 C	1"	4	KD	6



TRADITIONAL BRASS 55



- Solid brass body offers maximum corrosion resistance
- Available with hardened steel or brass shackle
- Inner components made from non-corrosive materials
- Perfect solution for outdoor security applications

Item	Shackle Height	Pins in Cylinder	Shackle Material	Key Options	Case Pk Qty
55/25 C	7/16"	3	Steel	KD, KA	12
55/30 C	33/64"	3	Steel	KD	12
55/30 B	33/64"	3	Steel	KD, KA	12
55MB/30 C	33/64"	3	Brass	KD	12

Item	Shackle Height	Pins in Cylinder	Shackle Material	Key Options	Case Pk Qty
55/40 C	7/8"	4	Steel	KD	12
55/40 B	7/8"	4	Steel	KD, KA	12
55MB/40 C	7/8"	4	Brass	KD, KA	12
55MB/40 B	7/8"	4	Brass	KD, KA	12
55HB/40 MB C	2 1/2"	4	Brass	KD	6
55/45 C	5/16"	4	Steel	KD	6
55/45 B	5/16"	4	Steel	KD, KA	6
55/50 C	15/16"	5	Steel	KD	6
55/50 B	15/16"	5	Steel	KD, KA	6
55MB/50 C	15/16"	5	Brass	KD, KA	6
55/60 C	1 1/4"	5	Steel	KD, KA	6



For easy ordering, call 800.352.ABUS, fax 623.516.9934 or email customerservice@us.abus.com | abus.com

TRADITIONAL BRASS 65



- Body made from solid brass
- Shackle made from hardened steel with NANO PROTECT™ coating
- Inner components made from non-corrosive materials
- Precision pin tumbler

Item	Shackle Height	Pins in Cylinder	Key Options	Case Pk Qty
65/20 C	$\frac{29}{64}$ "	3	KD, KA	6
65/40HB63 C	$2\frac{31}{64}$ "	5	KD, KA	6
65/50 C	$1\frac{5}{32}$ "	5	KD, KA	6
65/50HB80 C	$3\frac{5}{32}$ "	5	KD, KA	6



HIGH SECURITY BRASS 85

CHROME-PLATED BRASS 88

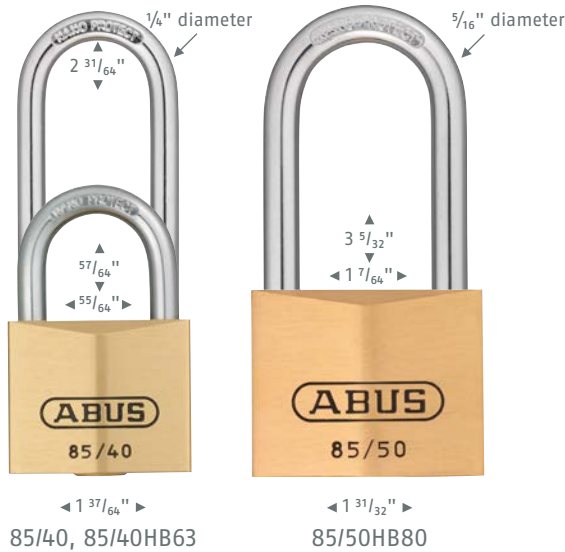

- Body made of solid brass
- Inner components made of non-corrosive materials
- Hardened steel shackle with NANO PROTECT™ coating
- Precision pin cylinder with mushroom pins
- Paracentric keyway for increased protection against manipulation
- Can be made keyed alike to already existing keys/locks
- Automatic locking: Locking without key by pushing down the shackle

- Lock body made from solid brass
- Chrome-plated lock body for better corrosion resistance
- Double bolted
- Shackle made from hardened alloy steel
- ABUS-Plus disc cylinder: highest protection against manipulation
- Cylinder can be re-keyed to match an existing key
- Key retaining: locking only with the key (lock retains key until locked)

Item	Shackle Height	Pins in Cylinder	Key Options	Case Pk Qty
85/40 B	$\frac{57}{64}$ "	5	KD, KA, MK	6
85/40HB63 B	$2 \frac{31}{64}$ "	5	KD, KA, MK	3
85/50HB80 B	$3 \frac{5}{32}$ "	5	KD, KA, MK	3

Item	Shackle Height	Pins in Cylinder	Key Options	Case Pk Qty
88/40 C	$\frac{57}{64}$ "	7	KD	6
88/40 B	$\frac{57}{64}$ "	7	KD, KA	6
88/50 C	$1 \frac{1}{64}$ "	7	KD	6
88/50 B	$1 \frac{1}{64}$ "	7	KD, KA	6



For easy ordering, call 800.352.ABUS, fax 623.516.9934 or email customerservice@us.abus.com | abus.com

CUSTOM LASER ENGRAVING



From our Monoblock to our KeyGarage™, custom engraving is available for a variety of ABUS padlocks. This unique feature will make your business stand out by customizing an ABUS padlock with your logo, symbols or simply adding your phone number and address.

Engraved padlocks can typically be delivered within 7 business days. Call your Inside Sales Account Representative at 800.352.ABUS for details. An engraving order form is available on page 52.

OUR LOCK, YOUR BUSINESS CARD.



WEATHERPROOF BRASS 70

BRASS 75IB

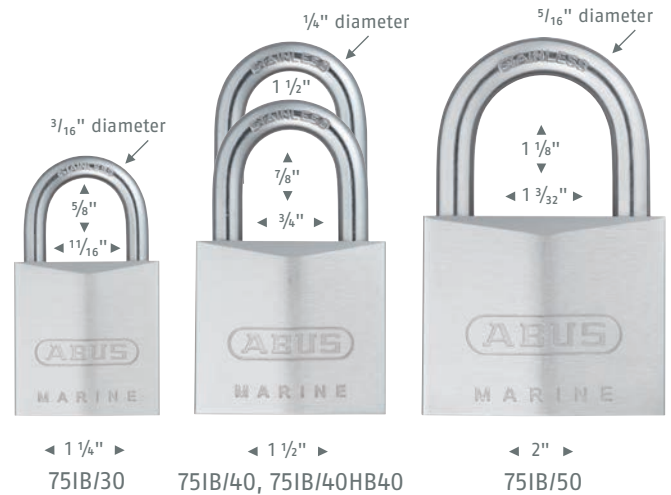
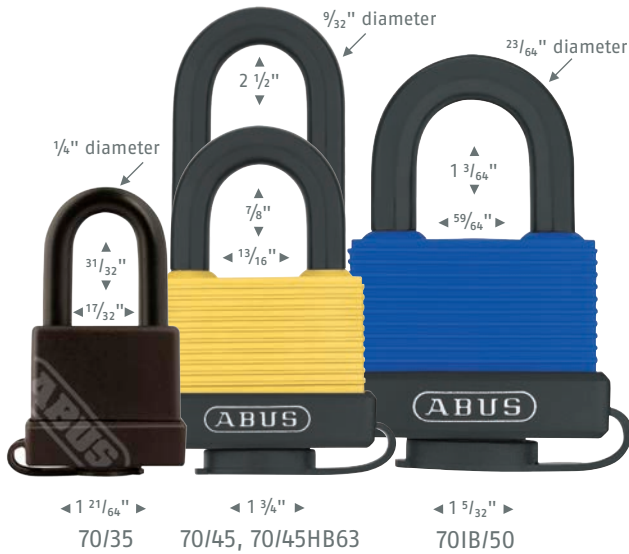

- Solid brass body with shock-absorbing vinyl cover provide ultimate weather resistance
- Cylinder cover with drainage channels protects padlock from water and dirt
- Inner components made from rust-free materials
- IB: comes with stainless steel shackle

- High-precision reversible keyway with up to 150,000 key differs
- Body made from solid brass or pearl-nickel-plated brass
- Shackle made from stainless steel
- Dimple key
- Key-retaining: 75IB/40 + 75IB/50
- Self-locking: 75IB/30



Item	Shackle Height	Pins in Cylinder	Key Options	Case Pk Qty
70/35 B	31/32"	4	KD	12
70/45 C	7/8"	5	KD, KA	6
70/45HB63 B	2 1/2"	5	KD, KA	6
70IB/45 C	7/8"	5	KD, KA, MK	6
70IB/45HB63 B	2 1/2"	5	KD, KA, MK	6
70IB/50 C	1 3/4"	5	KD, KA, MK	6

Item	Shackle Height	Pins in Cylinder	Key Options	Case Pk Qty
75IB/30 B	5/8"	8	KD, KA	12
75IB/40 B	7/8"	8	KD, KA	12
75IB/40HB40 B	1 1/2"	8	KD, KA	12
75IB/50	1 1/8"	10	KD, KA	6



For easy ordering, call 800.352.ABUS, fax 623.516.9934 or email customerservice@us.abus.com | abus.com

WEATHERPROOF BRASS 84IB

BRASS T84MB

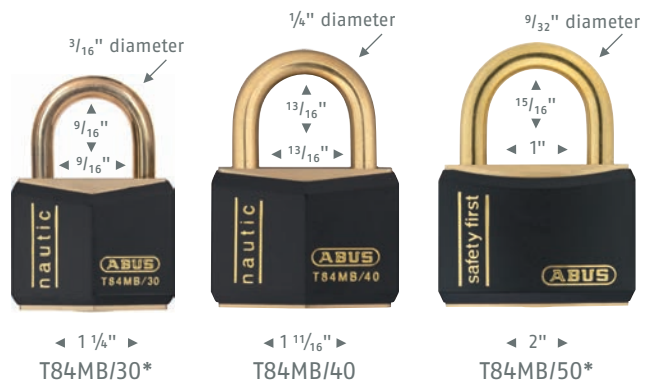

- Lock body made of nickel-plated solid brass
- Shackle made of stainless steel
- Inner components made of non-corrosive materials
- Precision pin tumbler
- Self-locking: locking without a key by pushing down the shackle

- Body and shackle made of solid brass
- Inner components made of non-corrosive materials
- Precision pin tumbler



Item	Shackle Height	Key Options	Case Pk Qty
84IB/40 C	53/64"	KD	6
84IB/50 C	31/32"	KD	6
84IBHB/50 C	2"	KD	6

Item	Shackle Height	Pins in Cylinder	Key Options	Case Pk Qty
T84MB/30* C	9/16"	3	KD, KA	12
T84MB/40 C	13/16"	4	KD	12
T84MB/40 B	13/16"	4	KD, KA	12
T84MB/50* C	15/16"	5	KD, KA	6



*Available only with black jacket.

MONOBLOCK BRASS 82

STEEL 92

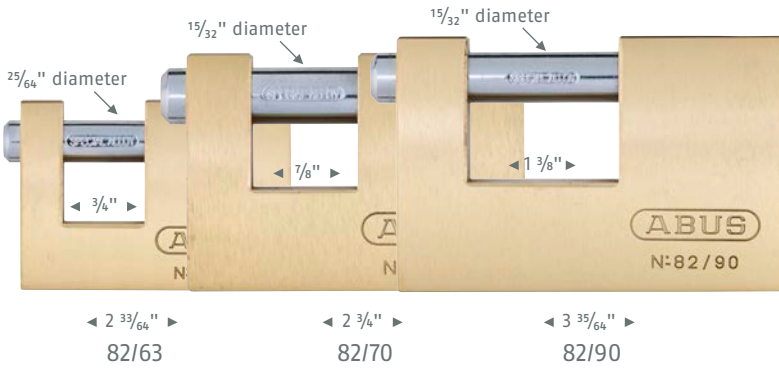

- Brass body offers strength and rust resistance
- Unique padlock design with hardened steel shackle and pin provides maximum resistance to bolt cutters
- Ultimate security when paired with ABUS security chain

- Body made from solid brass with steel jacket
- Hardened steel shackle with NANO PROTECT™ coating
- Precision pin tumbler
- Perfect for use with ABUS security chain

Item	Pins in Cylinder	Key Options	Case Pk Qty
82/63 B	5	KD, KA	6
82/70 B	5	KD, KA	6
82/90 B	5	KD, KA	6

Item	Pins in Cylinder	Key Options	Case Pk Qty
92/65 B	5	KD, KA	3
92/80 B	5	KD, KA	3



For easy ordering, call 800.352.ABUS, fax 623.516.9934 or email customerservice@us.abus.com | abus.com

TITALIUM™ 54TI

80TI



- Solid lock body made of TITALIUM™ aluminum alloy: light, but secure
- Hardened steel shackle, difficult to cut
- Just as strong as traditional brass padlocks



- Solid lock body made from TITALIUM™ aluminum alloy: higher security, less weight
- Hardened steel shackle with NANO PROTECT™ coating
- Paracentric keyway for increased protection against manipulation
- Just as strong as traditional brass padlocks

Item	Shackle Height	Pins in Cylinder	Key Options	Case Pk Qty
54TI/30 C	$35/64$ "	3	KD	6
54TI/35 C	$5/8$ "	3	KD	6
54TI/40 C	$53/64$ "	4	KD	6
54TI/40HB63 C	$2 \frac{31}{64}$ "	4	KD	6

Item	Shackle Height	Pins in Cylinder	Key Options	Case Pk Qty
80TI/40HB40 C	$1 \frac{9}{16}$ "	6	KD, KA	4
80TI/50 C	$1 \frac{3}{8}$ "	6	KD, KA	4



TITALIUM™ 64TI

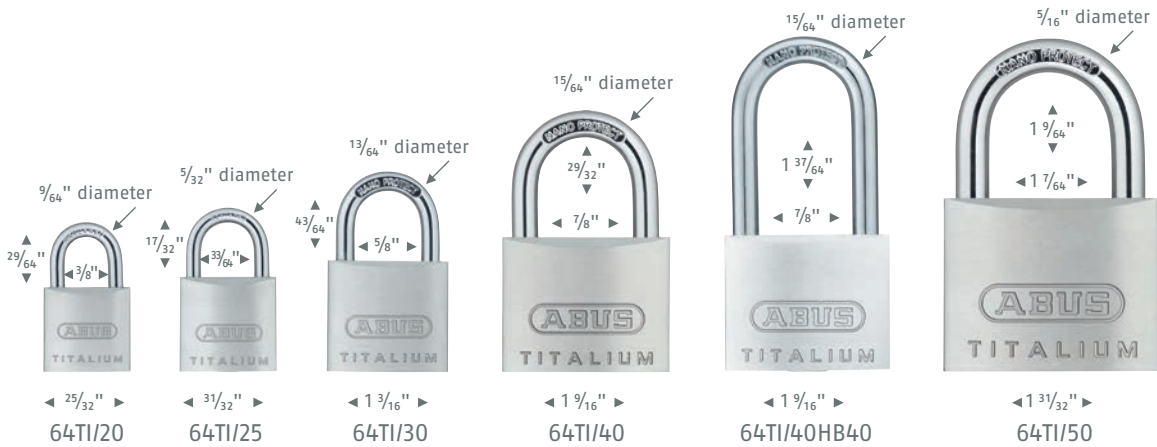

- Solid lock body made from TITALIUM™ aluminum alloy: higher security, less weight
- Hardened steel shackle with NANO PROTECT™ coating for superior corrosion resistance
- Paracentric keyway for increased protection against manipulation
- Just as strong as traditional brass padlocks

Item	Shackle Height	Pins in Cylinder	Key Options	Case Pk Qty
64TI/20 C	29/64"	3	KD	6
64TI/25 C	17/32"	4	KD	6
64TI/30 C	43/64"	4	KD	6
64TI/40 C	29/32"	5	KD	6
64TI/40HB40 C	1 37/64"	5	KD, KA	6
64TI/50 C	1 9/64"	5	KD, KA	6



For easy ordering, call 800.352.ABUS, fax 623.516.9934 or email customerservice@us.abus.com | abus.com

83 SERIES®

The Locksmith's Padlock of Choice



Features

KnK Cylinder Compatibility

Most OEM KnK cylinder assemblies will fit into the new 83 Series® padlocks. The use of special adapters is required. KnK Adapter Kit Includes: Bible Cover, Schlage® & Primus®, Medeco®, Mul-T-Lock®, Ilco®/Sargent KnK Drivers.



KnK Adapter Kit

Shackle Changing Tools

There are two new shackle changing tools for use with ABUS 83 Series®. Version 1 is a solid aluminum, steel tip tool designed for use in the workshop environment. Version 2 is an economy version of this tool, designed for use in a van or onsite and when only a smaller number of shackles needs to be changed. A flat bladed screwdriver can no longer be used to remove the shackle, reducing the likelihood of a consumer accidentally doing so.



Professional Aluminum Shackle Change Tool

Easy Shackle Change Feature

The popular "Easy Shackle Change" feature has been expanded to all 83ALs, 83/45, 83KnK/45, 83/50, 83MAR/45, 83WPIB/53, 83WP/53 and most IC padlocks.

Shackle Collar and Chain

With an ABUS shackle collar and chain, you can affix any one of our 83 Series® padlocks to a specific location to help prevent loss and contamination of the padlock. The shackle collar slides up the leg of the shackle and holds the chain attached to the padlock when open. Shackle collars are available for 5/16", 3/8" and 7/16" diameter shackles and can be purchased individually or in a collar kit which includes 6 collars of each size.



Shackle Collar

3-in-1 Bolt Driver

The 3-in-1 bolt driver setup has been retained for the large steel-bodied padlocks. Changing shackles becomes much simpler using this tools as the spring does not need to be reset. The 3-in-1 bolt driver is used in the 83/55, 83CS/55, 83/80 and 83WP/63 Series as well as all IC padlocks.



3-in-1 Bolt Driver

Symmetrical Z-Bar

A new 83 Series® Z-bar has been designed for use in converting from key-retaining to non-key-retaining in seconds. It looks similar to the existing Z-bar, but is symmetrical and has a black dot printed on it, distinguishing it from the old Z-bar which is produced with a red dot. The old Z-bar is shaped differently than the new Z-bar, therefore the two are not interchangeable.



New Z-Bar

83 Service Kit

ABUS 83 Series® Service Kit is the perfect way to keep all your parts for the 83 Series organized in your shop or in your van. The kit includes a variety of shackles for the 83/45, cylinders, KnK bible covers and adapters, Z-bars, Easy Shackle Change Tools and much more.



83 Service Kit

Cylinder Cover

A rubberized weatherproof cylinder cover is available for select 83 Series® padlocks. The cover fits snugly on the bottom of the lock and protects the cylinder from precipitation and debris.



Cylinder Cover

Keyways

100 YALE No. 8	200 Kwikset 5-Pin	300 & 306 Schlage C	EVER Schlage EVER	400 Corbin 60 59A1 59A2 5981 5982	410 Corbin L4	700 Sargent L4-LC	800 Weiser Falcon	888 ABUS	900 Arrow	1000 Russwin D1-D4	3000 Schlage C-L

Schlage C 300 is 6-5 pin loaded and Schlage C 306 is 6-6 pin loaded
Schlage Everest EVER is a composite that will fit all Everest C keyways

PROFESSIONAL TITALIUM™ 83

BRASS 83

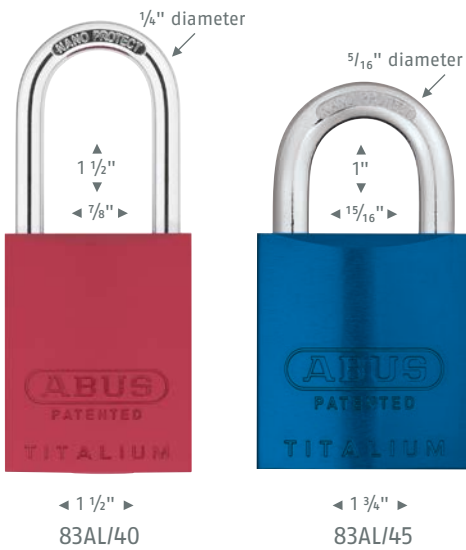

- Solid lock body made of TITALIUM™ aluminum alloy
- Shackle made of hardened steel with NANO PROTECT™ coating for extra corrosion resistance
- Patented "Z-bar" converts key-retaining to non-key-retaining and vice versa within seconds
- Patented "Pinning Window" for simple rekeying
- Can be keyed into many popular keyways
- Shackle can be changed in seconds

- Body made of solid brass
- Shackle made of hardened steel with NANO PROTECT™ coating for extra corrosion resistance
- Patented "Z-bar" converts key-retaining to non-key-retaining and vice versa within seconds
- Patented "Pinning Window" for simple rekeying
- Can be keyed into many popular keyways
- Shackle can be changed in seconds



Item	Cyl Cover Available	Shackle Height (in)	Pins in Cylinder	Case Pk Qty
83AL/40	Y	1, 1 1/2, 3, 4	5-6	6
83AL/45	Y	1, 2, 3, 4, 6	5-6	6
83AL-IC/40	Y	1, 1 1/2, 3, 4	-	6

Item	Cyl Cover Available	Shackle Height (in)	Pins in Cylinder	Case Pk Qty
83/40	Y	1, 1 1/2, 3, 4	5-6	6
83/45	Y	1, 2, 3, 4, 6	5-6	6
83CS/45	Y	1, 2, 3, 4, 6	5-6	6
83IC/45	Y	1, 2, 3, 4, 6	-	6
83KnKI/45	Y	1, 2, 3, 4, 6	-	6

*83AL/40 and 83/40 come standard with a 1 1/2" shackle



For easy ordering, call 800.352.ABUS, fax 623.516.9934 or email customerservice@us.abus.com | abus.com

HARDENED STEEL LFIC 83

PROFESSIONAL PLATED 83



- Body made from hardened steel with NANO PROTECT™ coating - same superior corrosion resistance as 83WP
- Hardened steel shackle with NANO PROTECT™ coating, available in different heights
- Padlock can be ordered without shackle to customize lock
- Accepts LFIC Schlage® cylinders
- Accepts all 83WP/53 compatible shackles
- Shackle can be changed in seconds

- Body made of chrome-plated solid brass
- Shackle made of hardened steel with NANO PROTECT™ coating for extra corrosion resistance
- Patented "Z-bar" converts key-retaining to non-key-retaining and vice versa within seconds
- Patented "Pinning Window" for simple rekeying
- Can be keyed into many popular keyways
- Shackle can be changed in seconds

Item	Cyl Cover Available	Shackle Height (in)	Pins in Cylinder	Case Pk Qty
83S/45 LFIC	N	1 3/16, 2 1/2, 3, 4	-	5-6

Item	Cyl Cover Available	Shackle Height (in)	Pins in Cylinder	Case Pk Qty
83/50	Y	1 3/64, 2, 3, 4	5-6	6
83CS/50	Y	1 7/64, 2, 3, 4	5-6	6
83IC/50	Y	1, 2, 3, 4	-	6
83KnK/50	Y	1, 2, 3, 4	-	6
83CS-KnK/50	Y	1, 2, 3, 4	-	6



STEEL ROCK 83

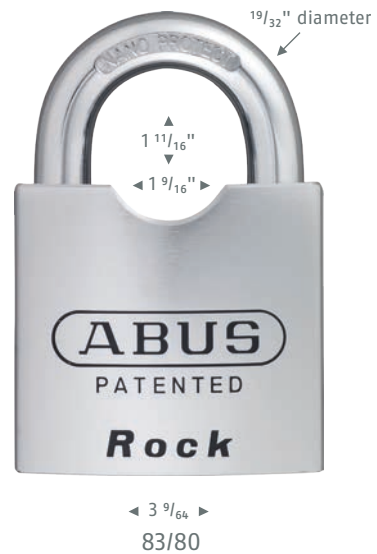
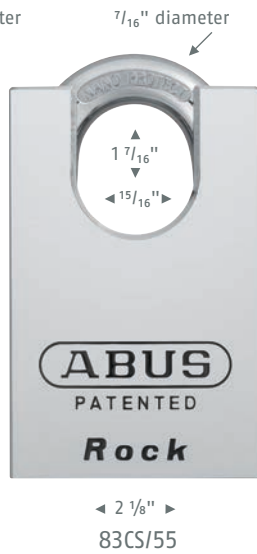

- Body and shackle made from hardened steel, chrome-plated with NANO PROTECT™ coating for an extreme corrosion resistance
- Patented "Z-Bar" converts key-retaining to non-key-retaining and vice versa within seconds
- RK: cylinder can be re-keyed to match an existing key
- CS: shackle guard protects shackle from attack

- Can be adapted to meet various requirements within seconds - no special tools needed
- Body and shackle made from hardened steel, chrome-plated with NANO PROTECT™ coating for an extreme corrosion resistance
- Double bolted
- Patented "Z-Bar" converts key-retaining to non-key-retaining and vice versa within seconds

Item	Cyl Cover Available	Shackle Height (in)	Pins in Cylinder	Case Pk Qty
83/55	N	1, 1 7/16, 3	5-6	6
83CS/55	N	1, 1 7/16, 3	5-6	6
83KnK/55	N	1, 1 7/16, 3	-	6
83CS-IC/55	N	1, 1 7/16, 3	-	6
83CS-KnK/55	N	1, 1 7/16, 3	-	6

Item	Cyl Cover Available	Shackle Height (in)	Pins in Cylinder	Case Pk Qty
83/80	N	1 11/16	5-6	6



For easy ordering, call 800.352.ABUS, fax 623.516.9934 or email customerservice@us.abus.com | abus.com

WEATHERPROOF 83

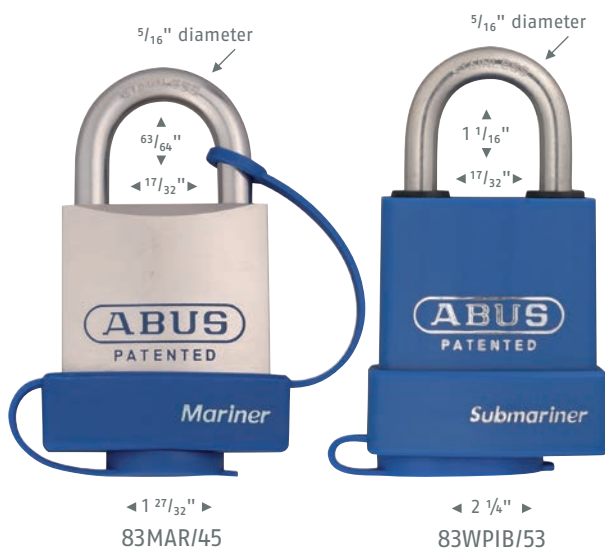

- Brass body with extra plating for perfect corrosion resistance
- Shackle made of stainless steel
- Durable weather cover with drainage system
- Patented "Z-bar" converts key-retaining to non-key-retaining and vice versa within seconds
- Patented "Pinning Window" for simple rekeying
- Can be keyed into many popular keyways
- Shackle can be changed in seconds

- Shackle and body made of hardened steel with NANO PROTECT™ coating for extra corrosion resistance
- RK: cylinder can be re-keyed to match an existing key
- Patented "Z-Bar" converts key retaining to non-key retaining and vice versa in seconds
- Patented "Pinning Window" for simple rekeying
- Durable weather cover with drainage system
- 83WP/53: shackle can be changed in seconds

Item	Shackle Height (in)	Pins in Cylinder	Case Pk Qty
84MAR/45	1, 2, 3, 4	5-6	6
83WPIB/53	1 1/8	5-6	6

Item	Shackle Height (in)	Pins in Cylinder	Case Pk Qty
83WP/53	1 1/16, 2 1/2, 3, 4	5-6	6
83WP-IC/53	1 1/16, 2 1/2, 3, 4	-	6
83WP-KnK/53	1 1/16, 2 1/2, 3, 4	-	6
83WP-LFIC/53	1 1/16, 2 1/2, 3, 4	-	6
83WP/63	1 3/8, 2 1/2	5-6	6
83WP-IC/63	1 3/8, 2 1/2	-	6
83WP-KnK/63	1 3/8, 2 1/2	-	6



INTERCHANGEABLE CORE

Features

- Accepts 6-pin and 7-pin SFIC cylinders
- Available in solid aluminum, solid brass, solid brass chrome-plated and solid hardened steel bodied padlocks
- Double-ball shackle locking
- Hardened steel shackle with NANO PROTECT™ coating for extreme corrosion resistance
- 3-in-1 bolt driver makes it easy to change shackles as the spring does not need to be reset
- Patented "Z-bar" allows padlock to be easily converted from non-key-retaining to key-retaining in seconds
- Shackles available in a choice of materials - hardened steel shackle with NANO PROTECT™ coating for extreme corrosion resistance, stainless steel and brass
- Shackles available in a range of lengths from 1" to 6"
- New! Exchange shackles in seconds with the easy shackle change tool (not available on 83AL-IC/40, 83CS-IC/55 or 83WP-IC/63)
- 83WP-LFIC/53 and 83S/45 LFIC accept LFIC Schlage® cylinders

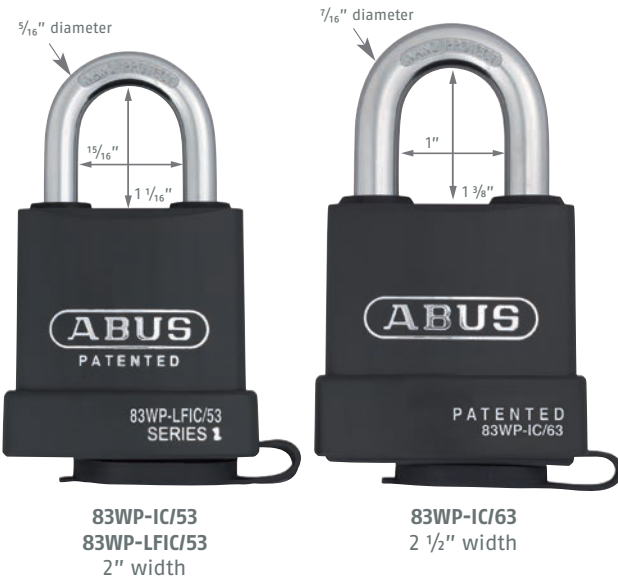
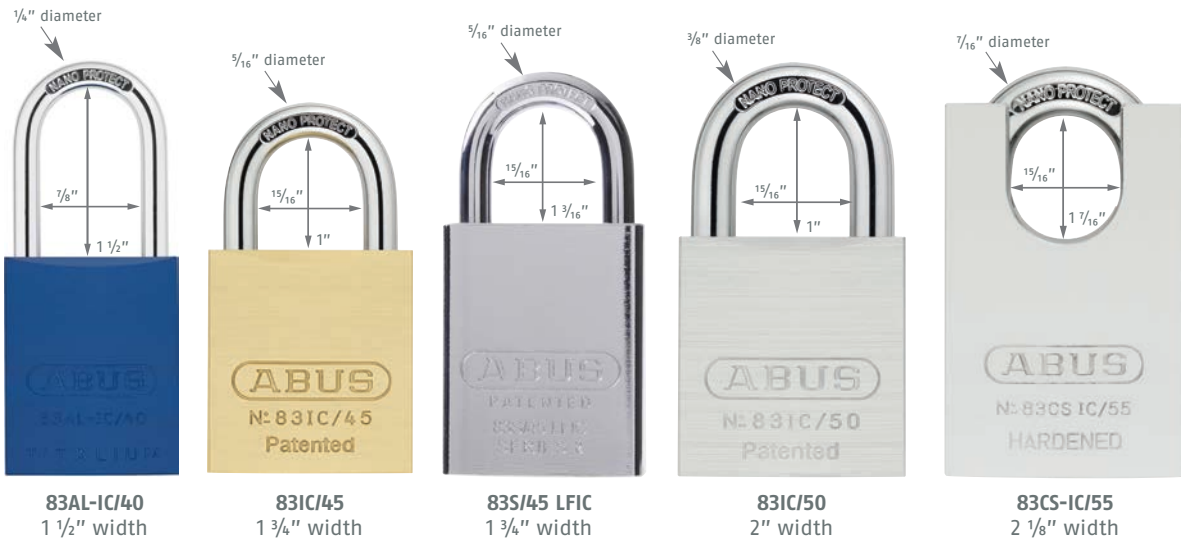

All Drivers Included



Item	Shackle Height (in)	Case Pk Qty
83AL-IC/40	1, 1 1/2, 3, 4	6
83IC/45	1, 2, 3, 4, 6	6
83S/45 LFIC	1 3/16, 2 1/2, 3, 4	6
83IC/50	1, 2, 3, 4	6
83CS-IC/55	1, 1 1/16, 3	6
83WP-IC/53	1 1/16, 2 1/2, 3, 4	6
83WP-LFIC/53	1 1/16, 2 1/2, 3, 4	6
83WP-IC/63	1 3/8, 2 1/2	6

DIAL COMBINATION 78



- 3-dial combination
- Extra protection against manipulation
- Hardened steel body
- Colored dial for individuality and easy recognition
- 78KC: Key Control - pin tumbler has master key function

Item	Shackle Height	Shackle Material	Case Pk Qty
78/50 C	27/32"	Steel	6
78KC/50 B	27/32"	Steel	12



COMBINATION 145

TSA 147/148



- Solid and lightweight aluminum body
- 3- or 4-digit individually resettable code
- Ideal for securing toolboxes, luggage, lockers, cabinets and more

- Individually resettable 3-digit code
- Visible red indicator at shackle: lock was opened by TSA
- To reset red indicator open lock and turn shackle by 360°



Item	Shackle Height	Dials	Shackle Material	Case Pk Qty
145/20 C	7/8"	3	Steel	6
145/30 C	63/64"	3	Steel	6
145/40 C	1 1/64"	4	Steel	6

Item	Shackle Height	Dials	Shackle Material	Case Pk Qty
147TSA/30 C	25/32"	3	Steel	12
148TSA/30 C	1 29/64"	3	Cable	12



For easy ordering, call 800.352.ABUS, fax 623.516.9934 or email customerservice@us.abus.com | abus.com

BAKPAK™ 151



COMBINATION 155



- Shackle diameter 1/8"
- Individually resettable 3-digit code
- Shackle opens by pressing the lever at the side



Item	Shackle Height	Dials	Shackle Material	Case Pk Qty
151/20 C	19 3/32"	3	Steel	12



- Hardened steel shackle
- Individually resettable 4-digit code

Item	Shackle Height	Dials	Shackle Material	Case Pk Qty
155/40 C	1 3/64"	4	Steel	6



COMBINATION 158

160



- Solid body made of zinc die-cast
- Double bolted shackle
- Shackle made from hardened steel
- 158/40: individually resettable 3-digit code
- 158/45KC and 158/50: individually resettable 4-digit code
- 158/45KC: override key available for purchase

- Solid chrome-plated zinc body
- Hardened steel shackle
- Polished chrome finish for superior weather resistance
- 160/40: individually resettable 3-digit code
- 160/50: individually resettable 4-digit code



Item	Shackle Height	Dials	Shackle Material	Case Pk Qty
158/40 C	$1\frac{1}{32}$ "	3	Steel	3
158/50 C	$1\frac{5}{16}$ "	4	Steel	3
158/45KC B	$\frac{63}{64}$ "	4	Steel	12

Item	Shackle Height	Dials	Shackle Material	Case Pk Qty
160/40 C	$\frac{57}{64}$ "	3	Steel	6
160/50 C	$1\frac{1}{32}$ "	4	Steel	6
160/50HB50 C	$1\frac{31}{32}$ "	4	Steel	6



For easy ordering, call 800.352.ABUS, fax 623.516.9934 or email customerservice@us.abus.com | abus.com

COMBINATION 180IB

190



- Solid forged brass body provides superior protection and weather resistance
- Stainless steel shackle and corrosion-resistant inner components for ultimate rust protection
- Precision locking mechanism with special protection against manipulation
- 4-digit resettable code
- Resetting tool included

- Heavy-duty combination lock
- Solid hardened steel jacket
- 4-digit resettable code
- Precision locking mechanism with special manipulation protection
- Shackle guard protects shackle from attacks

Item	Shackle Height	Dials	Shackle Material	Case Pk Qty
180IB/50 C	1"	4	Stainless	6
180IB/50HB63 C	2 1/2"	4	Stainless	6

Item	Shackle Height	Dials	Shackle Material	Case Pk Qty
190CS/60 C	1 3/16"	4	Steel	2



COMBIFLEX CABLE LOCK

MULTILOOP CABLE LOCK



1/16" cable diameter
25" cable length

2501/65



1/16" cable diameter
33" cable length

2502/85

- 3-digit individual resettable code
- Braided steel, automatic roll up cable
- Light weight plastic case
- Fits perfect in every pocket or bag



210/185

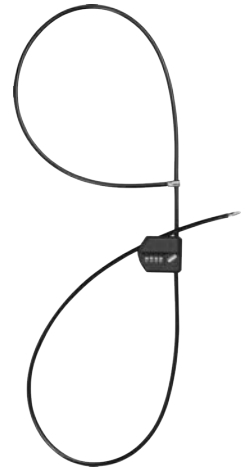

215/185

- 15/16" strong premium steel cable
- PVC-coating to prevent damage to surroundings
- Silicone coating on the lock body with "soft touch" properties for better grip
- Integrated adapter in the body for a conversion from one loop to a double-loop cable
- 210: Keyed, available keyed-alike or keyed-different
- 215: Combination

Item	Cable Length	Dials	Shackle Material	Case Pk Qty
2501/65 C	25"	3	Cable	3
2502/85 C	33"	3	Cable	3

Item	Cable Diameter	Cable Length	Body Material	Case Pk Qty
210/185 C	0.39	3	Steel	1
215/185 C	0.39	3	Steel	1



PUSH BUTTON KEYGARAGE™

DIAL KEYGARAGE™

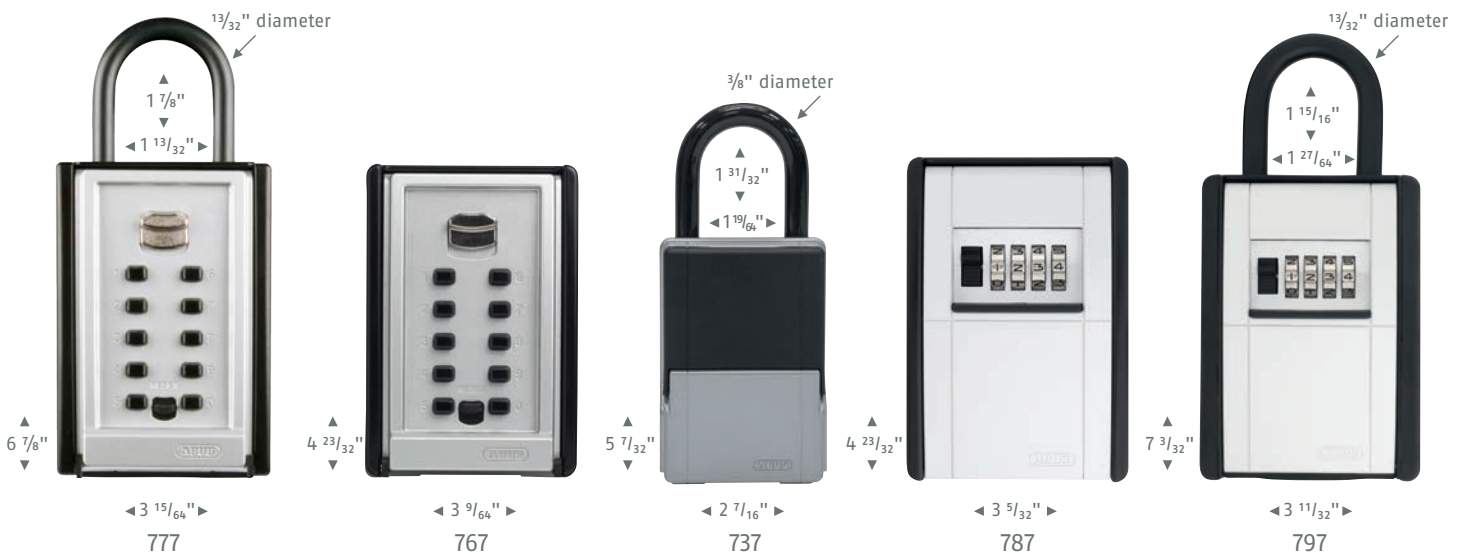

- Large solid metal housing offers more capacity than conventional key boxes
- 10 push-button resettable combination: Set your own PIN
- Push buttons provide faster access than dials
- Large hinged front door protects buttons
- 767: For wall mounting, 777: For attaching with shackle
- Holds up to 8 cards or 20 keys

- Ideal protected storage for keys and other valuables
- Solid metal housing; locking cover made from zinc die-cast
- 4-digit individually resettable code
- Protective cover with sliding mechanism
- 787: For wall mounting, 797: For attaching with shackle
- 787, 797: Holds up to 8 cards or 20 keys
- 737: Compact KeyGarage™ holds up to 6 keys

Item	Shackle Height	Buttons	Case Pk Qty
767 C	-	10	1
777 C	$1\frac{7}{8}$ "	10	1

Item	Shackle Height	Dials	Case Pk Qty
737 C	$1\frac{31}{32}$ "	4	1
787 C	-	4	1
797 C	$1\frac{15}{16}$ "	4	1



INTEGRAL HASP D141



- Universal hasp with integrated Diskus® lock
- Ideal for use on double doors (utility vans, storage sheds)
- Easy to operate with one hand
- Solid metal locking case prevents successful attacks on the integrated padlock
- Zinc-plated for extreme corrosion resistance
- Mounting hardware included (screws, drilling template and spacers up to 1/5" height)
- Available with or without Diskus® lock

Item	Body Material	Body Color	Case Pk Qty
D141/200 C (w/26/70 Diskus)	Steel	Black	13
D141/200 B (Hasp only)	Steel	Black	13
D141/200 C (w/26/70 Diskus)	Steel	White	13
D141/200 B (Hasp only)	Steel	White	13



For easy ordering, call 800.352.ABUS, fax 623.516.9934 or email customerservice@us.abus.com | abus.com

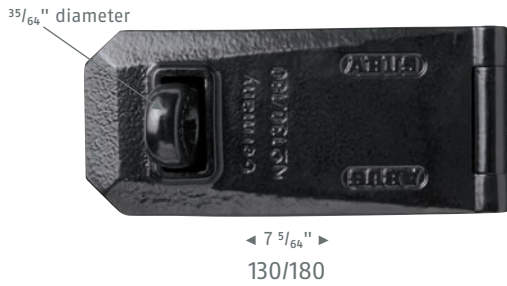

GRANIT™ HASP 130

- Two hardened hinge pins
- Tough white heart malleable iron
- Hardened staple
- Includes coach bolts and back plate



HARDENED STEEL HASP 125

- Extra-strong hinge
- Hardened staple
- Includes coach bolts and back plates
- Extremely high corrosion resistance



Item	Body Material	Case Pk Qty
130/180 C	White Heart Malleable Iron	1

Item	Body Material	Case Pk Qty
125/150 C	Coated Hardened Steel	3

Staple
Width: 5/8"
Height: 1/2"
Depth: 7/8"



4 11/16" 140/120
7 3/8" 140/190 (shown)

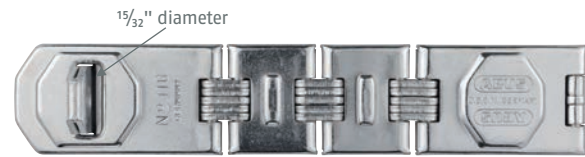

6 7/64" 110/155
7 43/64" 110/195
9 1/16" 110/230 (shown)

STAINLESS STEEL HASP 140

- Hasp and hinge pins made of stainless steel
- Tough construction with hardened staple
- Hinge pins protected against attack
- Ideal in combination with Diskus® padlocks



CONCEALED HINGE PIN HASP 110

- Hardened steel for extra strength
- Seamless eye loop prevents prying
- Center-lock pin resists being driven out at end
- Hidden screws and hinge pins for extra security



Item	Body Material	Case Pk Qty
140/120 C	Stainless Steel	3
140/190 C	Stainless Steel	3

Item	Body Material	Case Pk Qty
110/155 C	Hardened Steel	3
110/195 C	Hardened Steel	3
110/230 C	Hardened Steel	3



CONCEALED HINGE PIN HASP 100

- Hardened staple and hinge pins (not for 100/60)
- Concealed hinge pin
- Corrosion-protected
- Hidden screws



Item	Body Material	Case Pk Qty
100/60 C	Steel	3
100/80 C	Steel	3

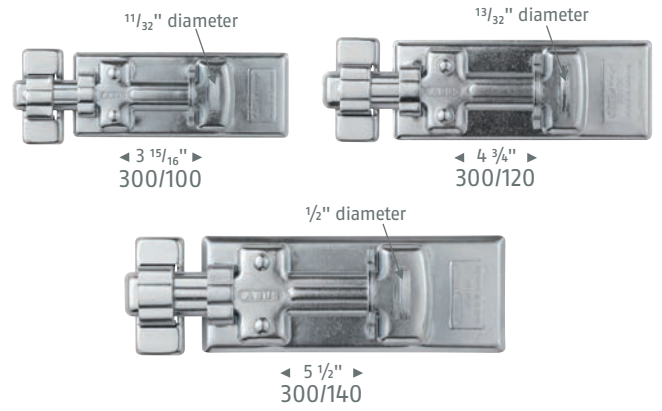

HARDENED HASP 300

- Hardened steel sliding locking bolt
- Zinc chrome finish for corrosion protection
- Hidden screws for extra security



Item	Body Material	Case Pk Qty
300/100 C	Zinc-coated Hardened Steel	6
300/120 C	Zinc-coated Hardened Steel	6
300/140 C	Zinc-coated Hardened Steel	6

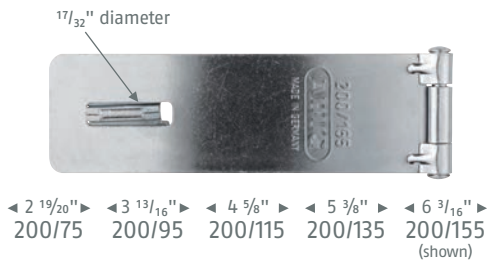

HARDENED HASP 200

- Hardened steel for extra strength
- Galvanized finish for corrosion protection
- Seamless eye loop prevents prying
- Hidden screws and hinge pins for extra security



Item	Body Material	Case Pk Qty
200/75 C	Hardened Steel	6
200/95 C	Hardened Steel	6
200/115 C	Hardened Steel	6
200/135 C	Hardened Steel	6
200/155 C	Hardened Steel	6

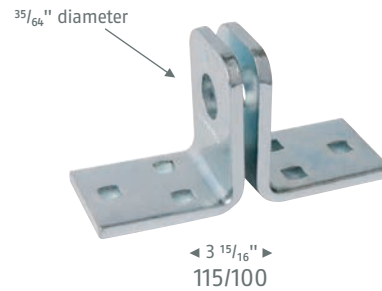

FIXED STAPLE HASP 115

- Corrosion-protected
- Hardened bolt
- Hidden screws



Item	Body Material	Case Pk Qty
115/100 C	Steel	3

COBRA STEEL CABLE

STEEL CABLE

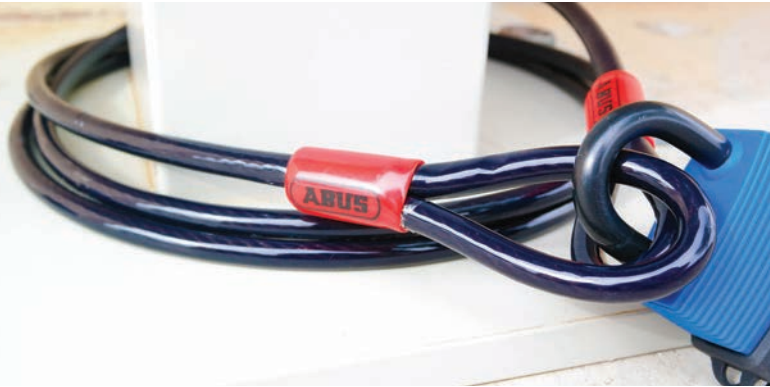

10/500 Cable



66 Cable

- Flexible steel cable
- ABUS loop cables protect bike components like front and rear wheel, frame and seat as the ideal complement to the ABUS U-shackle-locks, padlocks or frame locks
- Ideal to secure bicycles, surf boards, garden tools, etc.

- Braided steel wires for strength and flexibility
- Protective coating prevents scratching
- Self coiling for convenient storage

Item	Diameter	Length	Body Material	Case Pk Qty
8/200 Non-Coiled C	5/16"	78 47/64"	Steel	1
8/250 Non-Coiled C	5/16"	98 27/64"	Steel	1
10/500 Non-Coiled C	25/64"	196 27/32"	Steel	1
10/1000 Non-Coiled C	25/64"	393 45/64"	Steel	1
1850/185 Coiled B	5/16"	72 53/64"	Steel	1

Item	Diameter	Length	Body Material	Case Pk Qty
46 Coiled C	7/16"	72"	Steel	5
66 Coiled C	5/16"	72"	Steel	10
86 Coiled C	1/4"	72"	Steel	10

MAXIMUM SECURITY CHAIN



- Chain made from hardened steel
- Square-shaped links provide top security against all types of aggressive attacks
- Fabric sleeve prevents surroundings from damage
- Available in pre-cut (2', 6', 10') or custom lengths
- Loop chain comes with a larger loop on one end, making the chain go further

Item	Cutting Force	Inside Height	Thickness	Inside Width
6KS	4 tons	1 1/8"	1/4"	3/8"
8KS	6 tons	1 3/8"	5/16"	1/2"
10KS	8 tons	1 1/2"	3/8"	5/8"
12KS	10 tons	2 1/4"	1/2"	3/4"
14KS	12 tons	2"	9/16"	3/4"
12KS Loop 2.5'	10 tons	2 1/4"	1/2"	3/4"
12KS Loop 4'	10 tons	2 1/4"	1/2"	3/4"
12KS Loop 5'	10 tons	2 1/4"	1/2"	3/4"



12KS Loop

FLOOR & WALL ANCHOR

WALL ANCHOR



◀ 6 1/2" ▶
WBA100

- 6 5/16" shackle made of hardened steel for extreme resistance against the most aggressive attacks
- Extra wide shackle for easy locking
- Due to its flat shape and the use of high-quality plastic, it is possible to drive over the anchor in fixed position
- Can be used indoors and outdoors as wall or floor anchor
- Includes mounting hardware

Item	Case Pk Qty
WBA100	1



◀ 4 1/3" ▶
WA50

- Hardened steel wall anchor
- Can be used indoors and outdoors
- Includes hardware for wall or floor mounting

Item	Case Pk Qty
WA50	1

FILE CABINET BARS



- Constructed of 16-gauge steel
- Conveniently located knob allows easy and smooth operation
- Reversible for left and right side mounting
- Available in five different lengths
- Built-in spring-loaded hinge
- Mounting screws included
- Meets the DOD's Industrial Security Requirements



Item	Case Pk Qty
1-Drawer	10
2-Drawer	10
3-Drawer	10
4-Drawer	10
5-Drawer	10

VITESSTM HIGH SECURITY

What is ABUS Vitess™ High Security System?

The highest level of keyway security, ABUS Vitess™ High Security System is distributed under meticulous guidelines to protect the exclusivity of the individual true key profiles. Choose ABUS Vitess™ when the highest level of security and protection against unauthorized duplication is needed. ABUS Vitess™ High Security Key Control System meets the security requirements of locksmiths, distributors and end users.

ABUS locking systems offer the US market a new and innovative high security solution. Our advanced key control features are applied for patent (protection until 2034), with lifetime trademark thereafter (trademark applied). As an added security measure, we stock exclusive keyways. To increase security measures, our unique key shapes are not easily duplicated. This allows for the highest level of security.

Our high security locking systems are versatile. We work with our customers to build the right keying system for their needs. Our products are ideal for a variety of facilities, including court houses, law enforcement stations, universities, department stores, hotel and hospitality chains and much more. With our model of "local work supporting local economy," ABUS USA is proud to offer products to the US market that are stocked and assembled right here in the US.

Highlights

- Geographic exclusivity on key blanks
- Once granted, patents protect against unauthorized key manufacture through 2034
- Vitess™ precision paracentric curved key, unique intop system and profile check pin offer increased pick resistance with lifetime trademark (if granted and always renewed)
- Drill resistant cylinder housing and plug
- Pre-loaded housing reduces assembly time, no tools or follower necessary
- Extremely high tolerance creating less wear
- All key sections and master keying available at all levels of security
- ABUS cylinders and cores can be pinned using ABUS pinning kit
- Keys can be cut with commonly available key cutting machines with the purchase of the appropriate jaws
- Thicker curved keys for added strength
- Two-year product warranty and a life-time warranty against key breakage
- Made in Germany guarantees premium quality and a long product service life

ABUS Vitess™ Key Control Levels

ABUS Vitess™ High Security System consists of five programs:

Level 1: Dealer Open Non-Exclusive Keyway

Level 2: Regional Dealer Based Keyways, contracted to Dealer by Distributor assigned by zip code region

Level 3: National/Regional End-user/Institutional Exclusive Keyways, contracted and sold through normal channels of distribution

Level 4: National Distributor Exclusive Keyways, contracted to Dealer by Distributor

Level 5: State Dealer Based Keyways contracted to Dealer by Distributor

More details of each program along with initial investments can be found in the ABUS Vitess™ Price List.

Vitess™ Keyway Information

The Vitess™ High Security system uses true keyway differs. No sidebars are used, offering a higher security level. ABUS has over 3000 true keyway differs available.

Vitess™ Cylinder Form

Vitess™ locks and cylinders are available in two different forms:

COM (Combinated)

Fully assembled cylinder available KD, KA, MK. Includes two cut keys.

UNCOM (Uncombinated)

Pre-loaded housing with un-combinated cores and accessories. Key blanks sold separate.

Master Keying

ABUS Vitess™ locks and cylinders may be master-keyed to meet virtually any requirement. Contact Tech Support to discuss special needs.

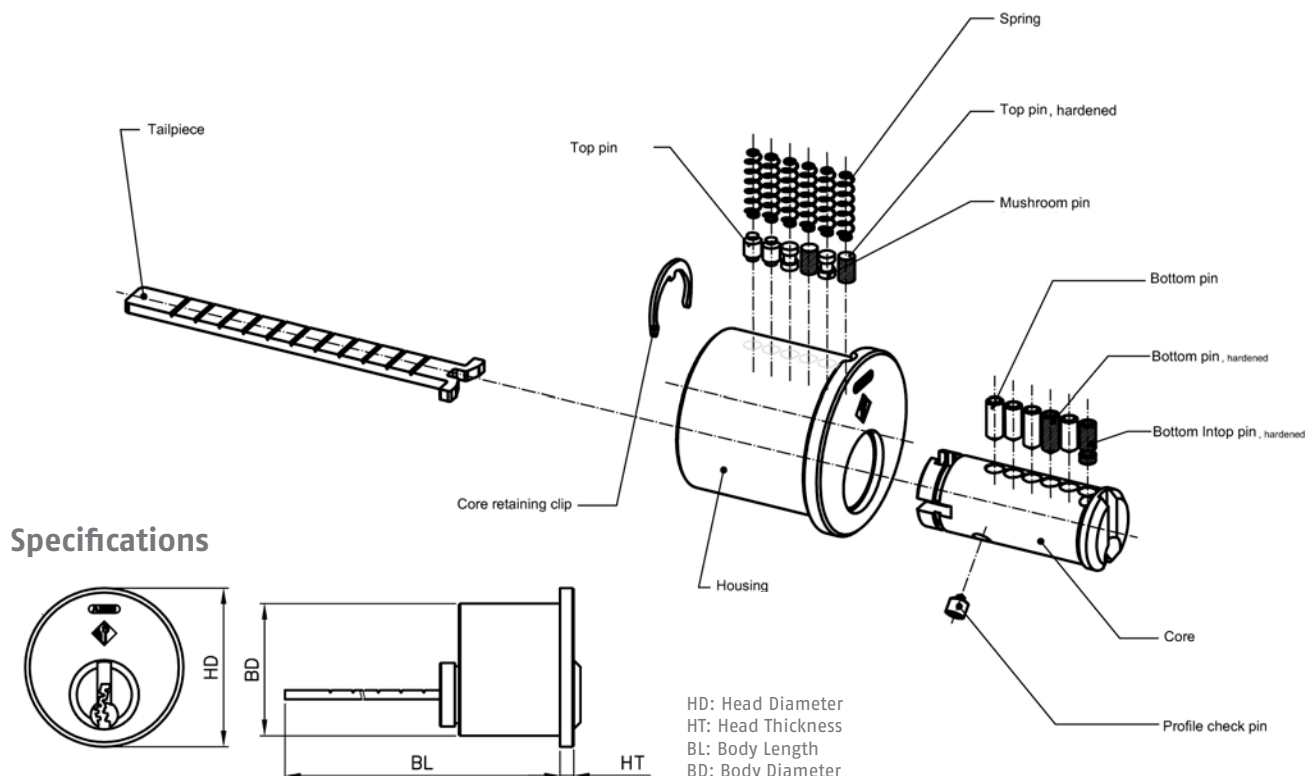

CONVENTIONAL RIM CYLINDERS

Commonly used on apartment and condominium doors, ABUS rim cylinders are used on vertical deadbolt locks and are also designed for commercial exit and panic devices. Rim cylinders are available with either horizontal (standard) or vertical break-off tailpiece.

Technical

- Cylinder housing and plug are made of high quality nickel-plated brass
- Key material: nickel silver
- Technical copy protection by Intop system
- Pinning: 4 pins made of nickel silver and 2 hardened steel pins in the 1st and 3rd position for increased drill protection
- 14mm diameter core advantage – more space to allocate up to 13 pin lengths which gives extremely high combinatory capabilities



Item	HD - Head Diameter	HT - Head Thickness	BL - Body Length w/cam	BD - Body Diameter
Rim Cylinder	1.337" (33.95mm)	0.118" (3mm)	1.075" (27.3mm)	1.146" (29.1mm)

RIM Cylinder Part Numbers

Part #	Description
10511	Rim Pre-Load Housing, Horizontal Tailpiece and Retaining Clip
10597	Rim Pre-Load Housing with Uncombined Core, Horizontal Tailpiece and Retaining Clip (Level 2, 3, 4, 5)
10514	Rim Cylinder Combined KD/KA, Horizontal Tailpiece w/ 2 cut keys
10599	Rim Core Uncombined (Level 2, 3, 4, 5)

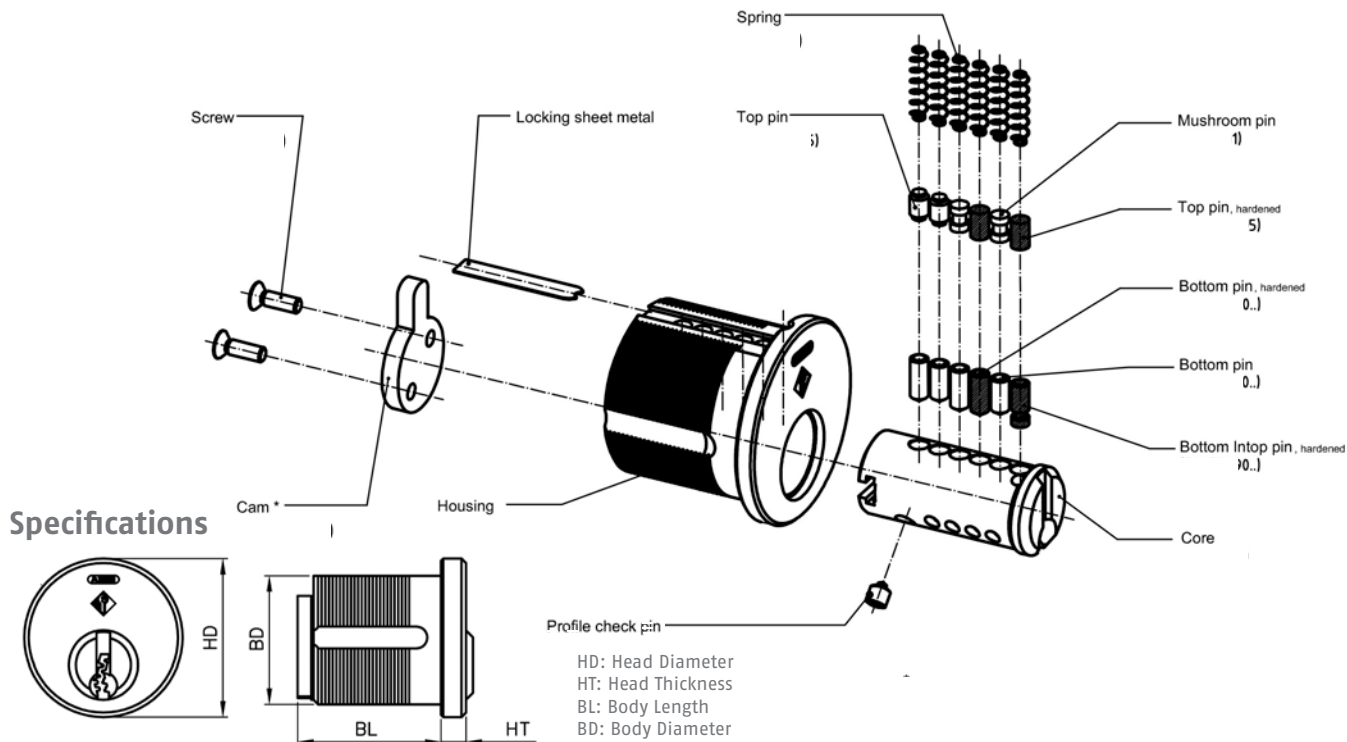

CONVENTIONAL MORTISE CYLINDERS

ABUS Vitess™ mortise cylinders are designed to replace several original manufacturers' cylinders in their locksets offering the highest level of security available on the market today. Made to standard U.S. dimensions, these rugged cylinders are available in a variety of finishes and lengths.

Technical

- Currently available in mortise housing lengths 1 1/8" and 1 1/4" with core extension
- Technical copy protection by Intop system
- Cylinder housing and plug are made of high quality nickel-plated brass
- Key material: nickel silver
- 5 mortise cam options available
- Pinning: 4 pins made of nickel silver and 2 hardened steel pins in the 1st and 3rd position for increased drill protection
- 14mm diameter core advantage – more space to allocate up to 13 pin lengths which gives extremely high combinatory capabilities



Item	HD - Head Diameter	HT - Head Thickness	BL - Body Length w/cam	BD - Body Diameter
1-1/8" Mortise Cylinder	1.370" (34.8mm)	0.138" (3.5mm)	1.042" (26.47mm)	1.150" (29.2mm)
1-1/4" Mortise Cylinder	1.370" (34.8mm)	0.138" (3.5mm)	1.200" (30.47mm)	1.150" (29.2mm)

CONVENTIONAL MORTISE CYLINDERS

Mortise Cylinder Part Numbers

Part #	Description
10500	Mortise 1-1/8" Pre-Load Housing, Adams Rite® Cam
10585	Mortise 1-1/8" Pre-Load Housing, w/o Cam
10586	Mortise 1-1/8" Pre-Load Housing with Uncombined core, Adams Rite® Cam (Level 2, 3, 4, 5)
10587	Mortise 1-1/8" Pre-Load Housing with Uncombined Core, w/o Cam (Level 2, 3, 4, 5)
10501	Mortise 1-1/8" Cylinder Combined KD/KA, Adams Rite® Cam w/ 2 cut keys
10589	Mortise 1-1/8" Cylinder Combined KD/KA, w/o Cam w/ 2 cut keys
10590	Mortise 1-1/4" Pre-Load Housing w/core extension, Adams Rite® Cam
10591	Mortise 1-1/4" Pre-Load Housing w/core extension, w/o Cam
10592	Mortise 1-1/4" Pre-Load Housing with Uncombined Core, Adams Rite® Cam (Level 2, 3, 4, 5)
10593	Mortise 1-1/4" Pre-Load Housing with Uncombined Core, w/o Cam (Level 2, 3, 4, 5)
10594	Mortise 1-1/4" Cylinder Combined KD/KA, Adams Rite® Cam w/ 2 cut keys
10595	Mortise 1-1/4" Cylinder Combined KD/KA, w/o Cam w/2 cut keys
10596	Mortise Uncombined Core (for 1-1/8" and 1-1/4") (Level 2, 3, 4, 5)

Cams for Conventional Mortise Cylinders

Order Code	SZ01	SZ06	SZ09	SZ11	SZ12
Description	Mortise Cam (Adams Rite®)	Mortise Cam (Schlage® L)	Mortise Cam (Sargent®)	Mortise Cam (Corbin Russwin®)	Mortise Cam (Yale®)

Part #	Description
10506	SZ01 Mortise Cam (Adams Rite®) *Standard Cam
10507	SZ06 Mortise Cam (Schlage® L)
10508	SZ09 Mortise Cam (Sargent®)
10509	SZ11 Mortise Cam (Corbin Russwin®)
10510	SZ12 Mortise Cam (Yale®)

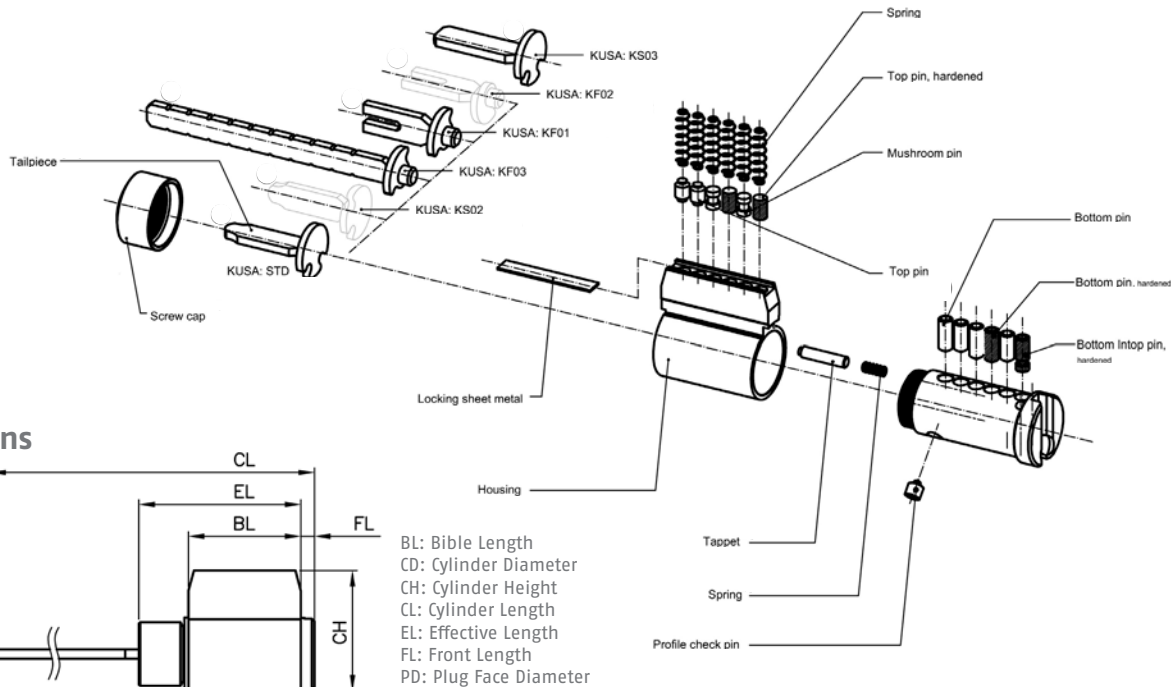

Specifications

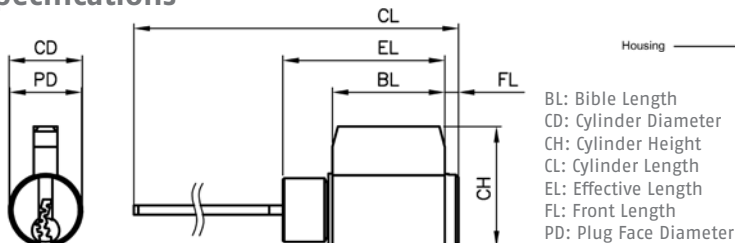

KEY-IN-KNOB/LEVER, DEADBOLT CYLINDERS

ABUS Vitess™ Key-in-Knob/Key-in-Lever and Deadbolt cylinders are designed to replace several original manufacturers' cylinders in their locksets offering the highest level of security available on the market today. These cylinders are manufactured to exact manufacturers' specifications to ensure precise fit and operation. ABUS Key in Knob/Key in Lever cylinders will improve the security of standard cylindrical locksets by Schlage® type cylinders.

Technical

- Cylinder housing and plug are made of high quality nickel-plated brass
- Key material: nickel silver
- Technical copy protection by Intop system
- Fixed tailpieces at the cylinder can be adjusted to horizontal or vertical orientation
- Tailpieces for free wheel function can be adjusted to different free-wheel positions. Free-wheel 180°
- Pinning: 4 pins made of nickel silver and 2 hardened steel pins in the 1st and 3rd position for increased drill protection
- 14mm diameter core advantage – more space to allocate up to 13 pin lengths which gives extremely high combinatory capabilities



Item	BL - Bible Length	CD - Cylinder Diameter	CH - Cylinder Height	CL - Cylinder length	EL - Effective Length	FL - Front Length	PD - Plug Face Diameter
KiK/KiL Cylinder	1.024" (26mm)	0.634" (16.1mm)	1.039" (26.4mm)	*see below	1.290" (32.76mm)	0.110" (2.8mm)	0.622" (15.8mm)
Tailpieces (*Cylinder length depends on tailpiece)		STD		KF03	KF01	KS03	
		Cylinder Length	2.15" (54.66mm)	3.62" (91.91mm)	2.07" (52.66mm)	2.21" (56.06mm)	

Key-in-Knob, Key-in-Lever and Deadbolt Cylinder Part Numbers

Part #	Description
10519	KnK/KiL Pre-Load Housing w/Tailpieces (4pk)
10600	KnK/KiL Pre-Load Housing with Uncombined Cylinder Core and Tailpieces (4pk) (Level 2, 3, 4, 5)
10520	KnK/KiL Cylinder Combined KD/KA w/Tailpieces (4pk) w/2 cut keys
10602	KnK/KiL Uncombined Core (Level 2, 3, 4, 5)

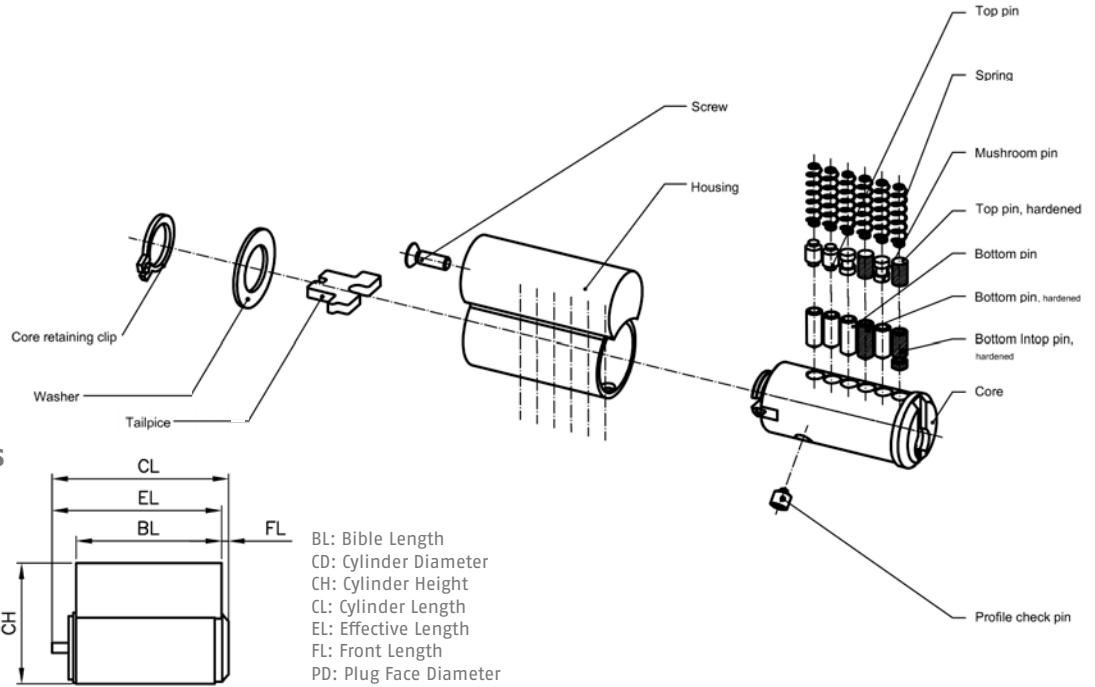

83 SERIES™ CYLINDER INSERT

ABUS manufactures heavy duty padlocks made from the highest quality materials that withstand the most rigorous testing procedures. Vitess™ 83 cylinder insert can be used together with ABUS 83 Series™ padlocks, now offering patented key control. The locking insert can be pinned without disassembling the core for quick assembly. ABUS padlocks are used in a wide variety of applications including storage rooms, perimeter fences, armories and more.



Technical

- Cylinder and housing made of high quality nickel-plated brass
- Key material: nickel silver
- Technical copy protection by Intop system
- Pinning: 4 pins made of nickel silver and 2 hardened steel pins in the 1st and 3rd position for increased drill protection
- 14mm diameter core advantage – more space to allocate up to 13 pin lengths which gives extremely high combinatory capabilities



Item	BL - Bible Length	CD - Cylinder Diameter	CH - Cylinder Height	CL - Cylinder length	EL - Effective Length	FL - Front Length	PD - Plug Face Diameter
83 Insert	1.283" (32.6mm)	0.632" (16.05mm)	1.053" (26.75mm)	1.526" (38.75mm)	1.490" (37.85mm)	0.035" (0.9mm)	0.587" (14.9mm)

83 Series Cylinder Insert Part Numbers

Part #	Description
10525	83 Series™ Pre-Load Housing
10603	83 Series™ Pre-Load Housing with Uncombined Core (Level 2, 3, 4, 5)
10526	83 Series™ Padlock Cylinder Combined KD/KA w/2 cut keys
10605	83 Series™ Cylinder Uncombined Core (Level 2, 3, 4, 5)

TUMBLER PINS

ABUS Vitesse™ system uses its own pins.

Technical

- ABUS Vitesse™ 14mm core allows for much more space to allocate more pin lengths
- Main competitors have a smaller core diameter
- Longer pins for less wear on pins and key top
- Pins made of nickel silver including hardened steel drill protection pins in the 1st and 3rd position



Tumbler Pin Part Numbers

Part #	Description
10536	Bottom Pin InTop "hardened steel" no. 5
10537	Bottom Pin "hardened steel" no. Z
10538	Bottom Pin "hardened steel" no. Y
10539	Bottom Pin "hardened steel" no. X
10540	Bottom Pin "hardened steel" no. 0
10541	Bottom Pin "hardened steel" no. 1
10542	Bottom Pin "hardened steel" no. 2
10543	Bottom Pin "hardened steel" no. 3
10544	Bottom Pin "hardened steel" no. 4
10545	Bottom Pin "hardened steel" no. 5
10546	Bottom Pin "hardened steel" no. 6
10547	Bottom Pin "hardened steel" no. 7
10548	Bottom Pin "hardened steel" no. 8
10549	Bottom Pin "hardened steel" no. 9
10550	Bottom Pin "nickel silver" no. Z
10551	Bottom Pin "nickel silver" no. Y
10552	Bottom Pin "nickel silver" no. X
10553	Bottom Pin "nickel silver" no. 0
10554	Bottom Pin "nickel silver" no. 1
10555	Bottom Pin "nickel silver" no. 2
10556	Bottom Pin "nickel silver" no. 3
10557	Bottom Pin "nickel silver" no. 4
10558	Bottom Pin "nickel silver" no. 5

Part #	Description
10559	Bottom Pin "nickel silver" no. 6
10560	Bottom Pin "nickel silver" no. 7
10561	Bottom Pin "nickel silver" no. 8
10562	Bottom Pin "nickel silver" no. 9
10575	Profile Check Pin
10563	Master Wafer no. 2
10564	Master Wafer no. 3
10565	Master Wafer no. 4
10566	Master Wafer no. 5
10567	Master Wafer no. 6
10568	Master Wafer no. 7
10569	Master Wafer no. 8
10570	Master Wafer no. 9
10571	Master Wafer no. 10
10572	Master Wafer no. 11
10573	Master Wafer no. 12
10574	Master Wafer no. 13
10608	Top Mushroom Pins
10609	Top Pin "hardened steel"
10610	Top Pin "nickel silver"
10611	Top Pin "hardened steel" (only used for cut 8/9)
10612	Top Pin "nickel silver" (only used for cut 8/9)
10613	Top Housing Spring

SPARE PARTS AND COMPONENTS

Mortise Cylinder Components Part Numbers

Part #	Description
10619	Mortise Cylinder Core Extender for 1-1/4"
10513	Cylinder Fixing Bolt for Mortise Cam (Pkg 50)

RIM Cylinder Components Part Numbers

Part #	Description
10512	Rim Core Retaining Clip (Pkg 50)
10577	Rim Cylinder Tailpiece Horizontal
10620	Rim Cylinder Tailpiece Vertical



KnK/KiL Cylinder Components Part Numbers

Part #	Description
10578	KnK/KiL Screw Cap
10579	KnK/KiL Tappet
10580	KnK/KiL Spring
10621	KnK/KiL Tailpieces (4pk)

83 Padlock Cylinder Insert Parts

Part #	Description
10581	83 Series™ Cylinder Core Retaining Clip
10582	83 Series™ Cylinder Core Washer
10583	83 Series™ Cylinder Core Tailpiece
10584	83 Series™ Cylinder Core Retaining Screw



KEYS AND KEYING

All ABUS keys are manufactured from the highest quality nickel silver material. The key's paracentric curved profile provides higher protection against picking and manipulation and key copy protection. The key bow size is perfect for easy identification and handling.

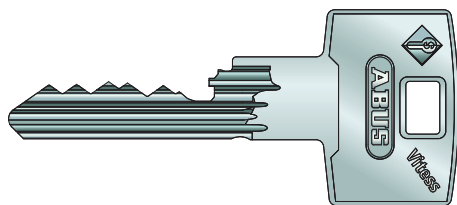

ABUS Vitess™ Key Blanks

- Innovative key design protected by U.S. and international intellectual property rights
- Patent applied key control offers the ultimate in high security
- Able to cut on most popular key machines with the purchase of appropriate jaw
- Custom coining die required for all programs, excluding Level 1 Open Locksmith Keyway
- Custom coining die with customers name or logo requires one time setup die fee of \$250 net. If initial order is 1000 keys (blank or cut), setup die fee is waived
- Graphic/Logos available upon request with no extra surcharge
- **Specify keyway when reordering**
- **NOTE:** Key blanks available in multiples of 100 only. Minimum order quantity of 500 for coined keys (cut or blank).

Part #	Description
10531	Vitess™ Key Blanks (Pkg 100)
10606	Vitess™ Cut Key

PINNING KIT

ABUS provides all the necessary tools for both the retail and institutional locksmith to service and maintain our locks in the field. The ABUS Vitess™ pinning kit is set up modularly, making it easy to access the parts needed.

- The ABUS Vitess™ pinning kit is a stable, durable plastic kit, which comes with all necessary components for the Vitess™ High Security program.
- The threefold latch with two buckles and a safety cover prevents unintentional opening.

Part #	Description
10531	Vitess™ Key Blanks (Pkg 100)

Technical

- High quality nickel silver material
- Key combination is read from tip to bow
- No. 9 pin is the longest with the deepest cut, No. 2 pin is the shortest, with the shallowest cut
- For pinning rules, please reference ABUS Vitess™ Service Manual

Warranty

ABUS guarantees that if a key should break under normal usage, ABUS will replace it at no charge

Form

ABUS Vitess™ Personalized Key Program Form, AV#28 needs to be completed and returned to ABUS USA to order your custom coined keys. This is required for all levels with the exception of Level 1, which is not available for custom coined keys.

Managing Key Blank Inventory

It is important to keep an accurate record of key blank inventory and a detailed log of keys issued in case a question arises. Each incoming order of ABUS Vitess™ blanks should be logged with a transaction on a Restricted Key Order Form, signed and dated by the employee who received and counted the blanks. All inaccurate cuts should also be documented on one of these forms, signed and dated by the employee who handled the transaction and logged into the main book. The total number of key blanks received, minus inaccurate cuts and keys issued, should always equal the number still on hand. The dealer should reconcile the log periodically and also log any discrepancies at that time. Discrepancies may indicate a breach in security or a careless employee.

Pinning Kit Contents

- Index with item numbers
- Labels for the single inserts
- Includes: Top and bottom hardened steel pins, top and bottom nickel silver pins, housing top springs, master wafers, profile check pin, mortise cams



SECURITY CARD

Technical

- ABUS Vitess™ Security Cards are used as authorization for the Vitess™ program
- Cards have a signature panel on the back and are issued by the servicing locksmith who directly supports the system owner
- The owner must present the I.D. card to obtain duplicate keys or additions to his system
- The signature will be validated by the dealer

Part #	Description
10622	Vitess™ Security Signature Card
10623	Vitess™ Security Signature Card - Duplicate/Replacement

Forms

- ABUS Vitess™ Security Card Order Form #AV27 needs to be completed and returned to ABUS USA to order your customized security cards
- ABUS Vitess™ Security Card Signature Registration Form #AV25 is kept on file with the Dealer for signature validation of the purchasing owner of the program



SUPPLIES, SERVICE EQUIPMENT & TOOLS

Part #	Description
10615	Complete Assembly Tool Kit
10616	Grooved Follower
10617	Filling Device 3pc Kit
10618	Plastic Plugs



Assembly Tool Kit



Follower



Filling Device

FORMS

All ABUS Vitess™ forms can be found online at www.abus.com/us/vitess.

#AV21 Vitess™ Confidentiality Agreement

All who purchase a Vitess™ program sign this document and return to ABUS USA.

#AV22 Vitess™ Distributor Agreement

Distributor, Dealer and ABUS USA sign this agreement when purchasing a Vitess™ program (Level 2 and higher). Distributor returns signed agreement to ABUS USA for signatures. ABUS USA returns fully executed agreements back to the Distributor and Dealer for their records.

#AV23 Vitess™ Dealer Agreement

Distributors have their Dealer sign this form when purchasing a Vitess™ program. The Distributor returns 3 originals to ABUS for signature and ABUS returns fully executed agreements back to Distributor to keep on file and Dealer.

#AV24 Vitess™ Source Authorization Form

This form is used if you already own a Vitess™ program and have a need to request another Distributor source for your program. This form is completed and returned to ABUS USA.

#AV25 Vitess™ Security Card Signature Registration Form

This form is for the Dealers to keep record of purchasing owners of a Vitess™ system. The owner signs the form and their security card for future verification when ordering duplicate keys or products. The Dealer keeps this form for their records on file.

#AV26 Vitess™ Master Key Request Form

This form is completed when ordering a master key system and returned to ABUS USA

#AV27 Vitess™ Security Card Order Form

This form is completed to order customized security cards with the Dealer's name on it and Dealer's Account numbers assigned by the Distributor they purchased the program from. This form needs to be returned to ABUS USA to order the security cards. (Required for levels 2-5)

#AV28 Vitess™ Personalized Key Program Order Form

This form is completed to order your personalized coined keys and returned to ABUS USA. (Required for levels 2-5) Level 1 is not available for coined keys.

ICON GLOSSARY

 **100% RUST-FREE**
All parts of the lock are made from non-corrosive materials

 **CORROSION RESISTANT**
Highly corrosion resistant due to surface protection

 **PARACENTRIC KEYWAY**
Resists professional picking by special key profile

 **DRILL PROTECTION**
Cylinder is protected against drilling and leverage

 **BOLT CUTTER PROTECTION**
Bolt cutter attack resistant

 **SAW RESISTANT**
Saw attack resistant

 **HAMMER RESISTANT**
Hammer & impact attack resistant

 **HARDENED SHACKLE**
Shackle made from hardened steel

 **CORROSION PLATING**
Sophisticated plating for extreme corrosion resistance

 **ALUMINUM ALLOY**
Lock body made from special aluminum alloy - light but secure

 **GERMANY**
Development and production in Germany

 **SHACKLE GUARD**
Shackle access restricted, protecting shackle from attack

 **STEEL BALL LOCKING**
Solid steel ball locking

 **DOUBLE-BOLTED**
Both sides of the shackle are secured by bolts or balls – increased protection against attacks and manipulation

 **SELF-LOCKING**
The lock is locked automatically by pushing down the shackle – no key needed for locking

 **KEY-RETAINING**
A key is needed for locking. Lock retains key until locked

 **RK AVAILABLE**
Cylinder can be taken out and can be rekeyed to match an existing key

 **KA AVAILABLE**
Available keyed-alike (several locks with the same key)

 **MK AVAILABLE**
Available master-keyed (one key opens many different locks)

 **RESETTABLE CODE**

 **ABUS-PLUS**
Original ABUS-Plus disk cylinder – highest precision, highest security

 **DIMPLE KEY**
No sharp edges and can be inserted either way up

 **LED KEY**

 **CODE CARD**
Spare keys are made only upon presentation of Code Card

 **SAMPLE KEY AVAILABLE**
New locks can be made up to a sample key

 **UL VALIDATED**

 **SUSTAINABLE SOLUTIONS**

Custom Engraving Form

Engraving includes logos and characters. Logo engraving requires vector artwork.

Price for engraving logos and characters is \$1.00 net per padlock area/per lock. There is a \$20.00 one-time set up fee for orders under 100. Call customer service at 800.352.2287 for any questions. Fax 623-516-9934 or email customer.service@us.abus.com.

Engraving Options

Please provide engraving information below.

I would like sequential numbering on keys and padlocks.

I would like text engraved on the following lock body areas:

- Area 1 Area 2
- Area 3 Area 4

I would like my logo engraved on the following lock body areas:

- Area 1 Area 2
- Area 3 Area 4



1/8" Letter Size (12pt)

Area 1 (front) _____
3 rows, 17 char. per row

Area 2 (right) _____
2 rows, 10 char. per row

Area 3 (back) _____
3 rows, 17 char. per row

Area 4 (left) _____
2 rows, 10 char. per row

1/4" Letter Size (24pt)

Area 1 (front) _____
2 rows, 12 char. per row

Area 2 (right) _____
1 row, 6 char.

Area 3 (back) _____
2 rows, 12 char. per row

Area 4 (left) _____
1 row, 6 char.

Customer Information

Custom engraving form must accompany purchase order.

End-User Company Name _____

End-User Contact Person _____

Phone Number _____

Distributor Name _____

Distributor P.O. Number _____

Order Summary

Sequential numbering _____ Start with _____ end with _____

Engraving areas per lock _____ x \$1.00 net per area \$ _____

Key number stamping _____ x \$1.00 net per area \$ _____ Total \$ _____

Lock Description _____

Quantity Ordering _____

KEY BLANKS

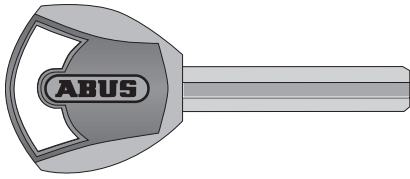

90040 ABUS PLUS
Works with: 20, 37, 88

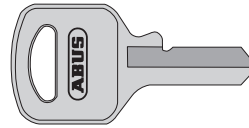

90130
Works with: 55/25, 54TI/25

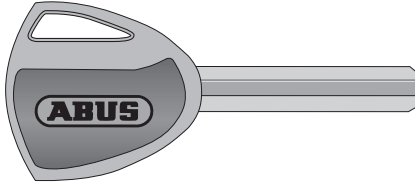

90042 ABUS PLUS LED
Works with: 20, 37, 88

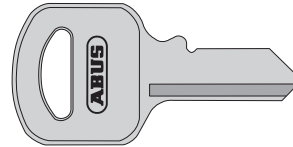

90140
Works with: 55/30, 54TI/30

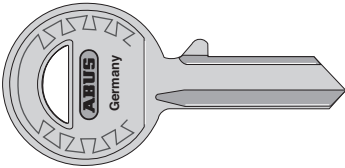

KBR: 90010, KBL: 90020
Works with: 24IB/(50, 60, 70) 28/70KA, 41/(30, KA/MK 4-pin)

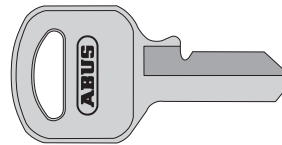

90140
Works with: 55/35, 54TI/35

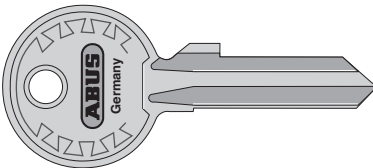

KBR: 90015, KBL: 90016
Works with: 24IB/70KD, 24RK, 26, 28/70, 41KD 5-pin

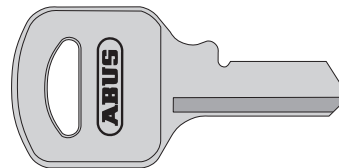

90150
Works with: 55/40, 54TI/40

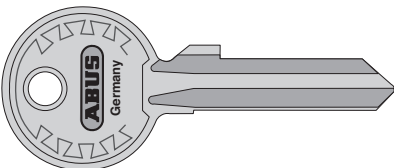

KBR: 90420, KBL: 90430
Works with: 24, 26, 82/(62, 70), 92/65 5-pin

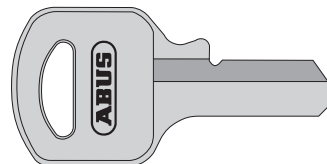

90160
Works with: 55/45, 54TI/45

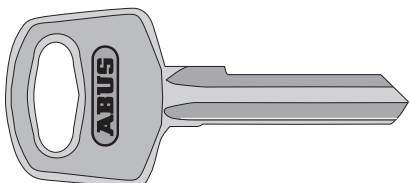

90085
Works with: 34/55, 34CS/55

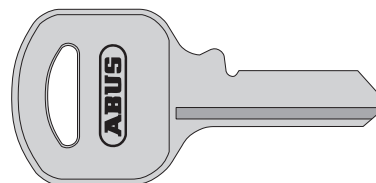

90170
Works with: 55/50, 54TI/50

90018
72/40, 74

KEY BLANKS

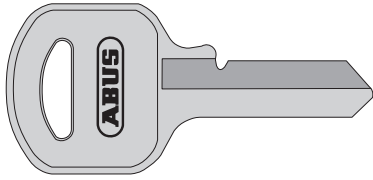

90180
Works with: 55/60, 54TI/60

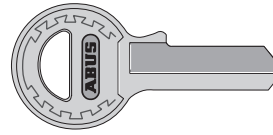

90220
Works with: 65/20

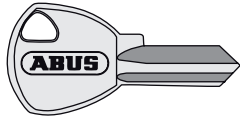

90185
Works with: 64TI/20

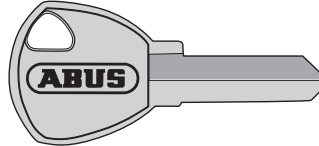

90230
Works with: 65/30 + 35 Old

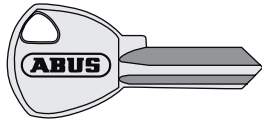

90184
Works with: 64TI/25

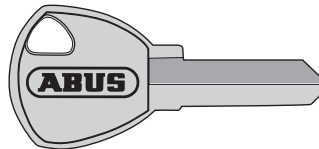

90233
Works with: 65/30 + 35, 64TI/30 + 35 New



90190
Works with: 65/15 L

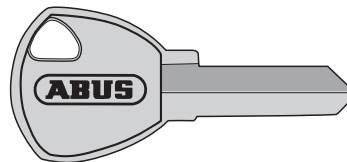

90240
Works with: 65/40 + 45 Old

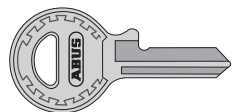

90200
Works with: 65/15 R

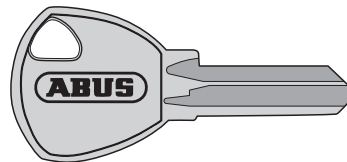

90243
Works with: 65/40 + 45, 64TI/40, T65, 70, 70AL

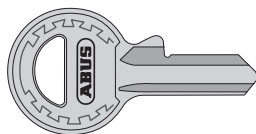

90215
Works with: 65/20

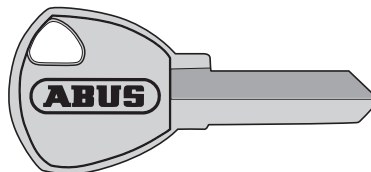

90250
Works with: 65/40 + 45, 64TI/40, T65, 70, 70AL

KEY BLANKS

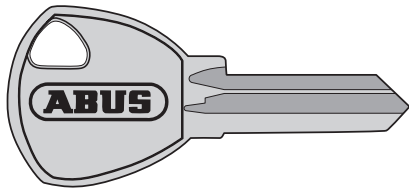

90183

Works with: 65/50 + 60, 64TI/50 + 60

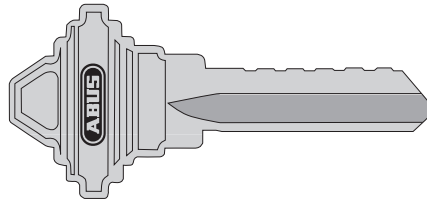

83017A

Works with: 83 Series - #300 Schlage

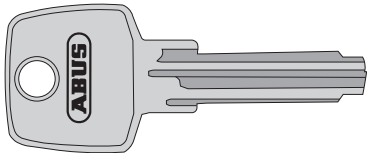

90255

Works with: 75/30 + 40, 25/70

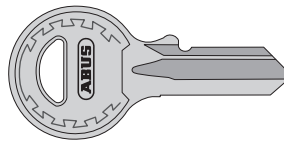

90320

Works with: T84MB/30 L

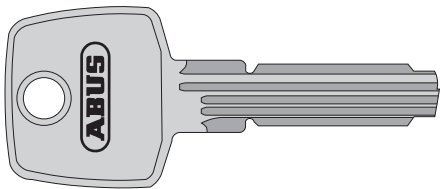

90256

Works with: 75/50 + 60

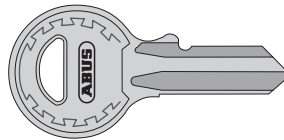

90330

Works with: T84MB/30 R

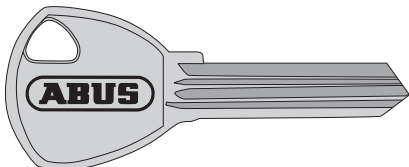

90186

Works with: 80TI/40 + 50

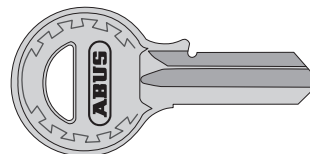

90340

Works with: T84MB/40 L

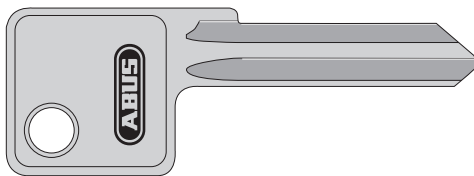

83618A

Works with: 83 Series - #100 Yale No. 8

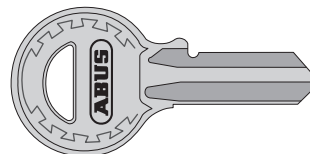

90350

Works with: T84MB/40 R

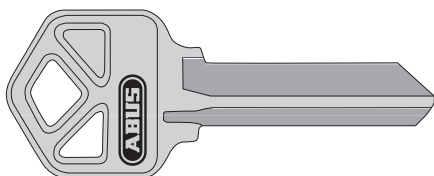

83016

Works with: 83 Series - #200 Kwikset

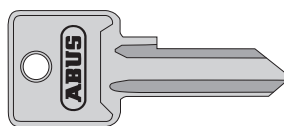

90390

Works with: 85/20 + 25 R

KEY BLANKS

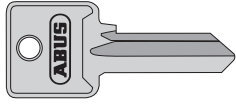

90380

Works with: 85/20 + 25 L

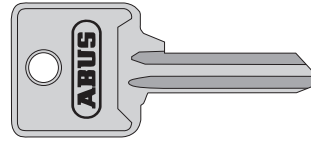

90430

Works with: 85/40 R, 82/63 + 70

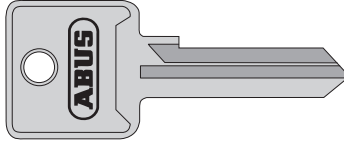

90400

Works with: 85/30 L

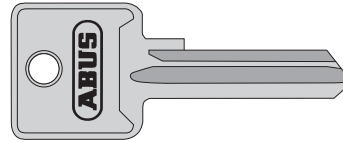

90440

Works with: 85/50+60 L, 82/90

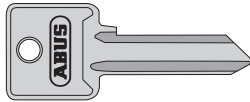

90410

Works with: 85/30 R

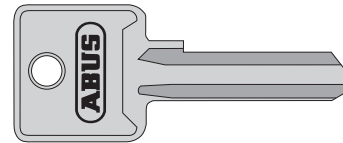

90450

Works with: 85/50+60 R, 82/90, 92/80

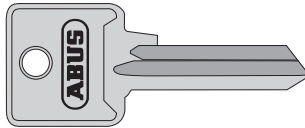

90420

Works with: 85/40 L, 82/63 + 70

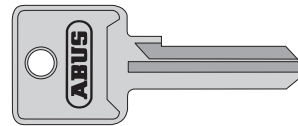

90590

Works with: 85/70 L

INFORMATION AND CONDITIONS

STANDARD TERMS & CONDITIONS

ABUS USA, LLC ("ABUS"), a division of the ABUS Group and all of its subsidiaries and related companies (future or currently existing) reserve the right to refuse an order, in its entirety or in part, when the credit of the Purchaser is judged not to be satisfactory in our absolute discretion. Furthermore, ABUS and its affiliates may refuse an order when the type or quantity of goods being requested does not conform to our ordering specifications.

The following conditions and terms incorporated herein constitute the entire agreement between the parties. Sales quotations, sales quotation requests, purchase orders or other forms of acknowledgment issued by the Purchaser that have contradictory terms and conditions do not bind ABUS or its affiliates to any other terms and conditions beyond those encompassed in this agreement. Only with separate written agreements written by ABUS or its affiliates and authorized by an ABUS representative may alternative terms and conditions be considered or referenced.

When ABUS accepts the Purchaser's purchase order, the Purchaser agrees that they accept the terms and conditions as described in this agreement regardless of the terms and conditions that may be specified in the Purchaser's purchase order. In the event when the Purchaser's purchase order terms and conditions and the terms and conditions specified in this agreement conflict, the Purchaser's terms and conditions will be disregarded and denied and the Purchaser agrees that this agreement shall constitute the entire agreement between the Purchaser and ABUS. In the event or circumstance that the enforcement of the terms and conditions of this agreement hereof is not conducted by ABUS or any other instrument, document, or alternative agreement relating to the goods being sold, such lack of enforcement will not waive, affect or reduce any right of ABUS in the future to require/enforce strict performance of such terms and agreements.

PRICES

All prices are subject to change without advance notice and are not guaranteed. All orders received by ABUS are deemed submitted at applicable prices in effect at the time of shipment pursuant to the terms and conditions outlined below. Possession of this catalog, ABUS Price List or other officially authorized ABUS documents, sales literature, catalogs does not constitute an agreement to sell. We reserve the right to correct clerical and other types of errors at any time. All prices are stated in US dollars.

TERMS

Decisions concerning the extension of trade credit are made by ABUS in its absolute sole discretion. Distributors/Purchasers who satisfy ABUS' ordinary credit criteria will be able to purchase products from ABUS at Net thirty (30) days. A service charge of 1% per month shall be imposed on the unpaid balance of any delinquent invoices. COD or Cash in Advance orders do not qualify for any term discounts. Furthermore, the Customer/Distributor/Purchaser shall be responsible for costs involving collections, court cost and or attorney's fees in association with the recovery of any overdue amounts.

RETURNED CHECKS

NSF checks will be charged a \$30 returned check fee. Returned checks are required to be paid by money order, cashier's check, or credit card. ABUS reserves the right to revoke open terms and change the account to Credit Card Required if we receive more than two returned checks for an account in any 90 day time period.

CREDIT HOLD POLICY

ABUS reserves the right to hold orders for any account that is past due.

STATE RESALE TAX CERTIFICATE

ABUS is required by law to have a valid resale tax certificate on file for each customer that makes a tax-exempt purchase. It is very easy to confuse the Resale Tax Certificate with a sales tax license, registration, or resellers permit number. The Resale Tax Certificate applies to the purchase(s) of goods for resale and proves that sales tax does not need to be collected; the purchaser must collect sales tax when the goods are resold. There are state specific laws that must be followed. Unfortunately, there is no one form that can be used in all states. ABUS must have a Resale Tax Certificate for each dealer for each state, and may have multiple Resale Tax Certificates for a customer. Some Resale Tax Certificates expire, so ABUS must monitor the validity and be certain that Resale Tax Certificates on file are current.

ACCOUNT CHANGES

For your protection, any changes to your business such as name, address, phone/fax number, contact personnel, or ownership must be submitted to ABUS in writing by a principal and then sent via fax or USPS to us.

CHANGES & CANCELLATIONS

Changes to or cancellations of orders must be made in writing and delivered by email, fax or regular mail. Cancellations made after ABUS has issued an order acknowledgment are subject to ABUS approval, and are subject to a \$25 processing fee in addition to any cost incurred by ABUS as a result of the original order.

QUOTATIONS

If and when ABUS chooses to provide an official sales quote, the quote will be valid for thirty (30) days. Complete shipment of the order must be accepted by the Purchaser within six (6) months from the date of issuance. Sale quote numbers (SO #'s) and possible project names must be referenced on the order. The sales quote is considered null and void if the Purchase Order does not reflect all of the product lines on the original sales quote or if the quantities for an item found in the quote deviate fifteen (15) percent or more. The Purchaser must request a new quotation.

Amendments, changes or modifications to an original sales quote will be accepted for up to thirty (30) days from the date of the original quote. All modifications must reference the original sales quote number. With the acceptance of the sales quote for the purchase of products, the Purchaser agrees that the products or services being purchased will not be resold or transferred to any distributor not sanctioned/authorized by ABUS to sell its products. This includes all branches and affiliates of the distributor. Failure to adhere to this restriction may result in the distributor's loss in eligibility for quotes or services at ABUS' sole discretion.

FREIGHT POLICY

ABUS will prepay freight on deliveries to customers provided the following conditions are met (customers in Alaska, Hawaii, Puerto Rico, and Canada are excluded and should contact ABUS USA, LLC for information regarding applicable freight charges):

1. The order must be for a minimum of \$750 to qualify for prepaid freight.
2. Payment of invoices is within terms. (i.e. freight will not be prepaid on orders to customers with past due invoices).
3. ABUS reserves and shall have the absolute right to select and employ the most economical carrier. If the customer specifies routing that results in higher freight costs, then ABUS' invoice will include the difference, which the customer agrees to pay.
4. All shipments are FOB (Freight On Board) ABUS US, Phoenix, AZ. Title of goods passes to customer upon delivery thereof by ABUS to the carrier or delivery service. Thereupon, the purchaser assumes fully the risk of loss.

CLAIMS

All claims for shipping and/or invoicing differences must be submitted within 10 days of receipt of shipment. Upon delivery to or pickup by the carrier, title passes and shipments become the property of the customer.

The customer assumes the risk of and makes claims for any loss, shortage or damage in transit.

RETURNS

Requests to return ABUS products should be made within 10 days from date of order and ABUS reserves the right to request date of manufacture and other product information. On goods returned for customer convenience, ABUS requires product be in new, resellable condition and in the original, unaltered packaging.

An RMA (Return Material Authorization) must be obtained from authorized personnel of ABUS before any product may be returned. RMA number must be clearly marked on the outside of the return package. Upon inspection by ABUS, a decision will be made to issue a credit for the ABUS product. This decision will be made solely by ABUS in accordance with the provisions of these Terms. Merchandise returned to ABUS in original unopened cartons is subject to a 15% restocking fee. Merchandise returned in an unsellable state (damaged blisters, product cards etc.) will be subject to an additional 20% repackaging fee.

Obsolete products will not be accepted for return. Transportation charges and insurance on all returned materials must be prepaid by the purchaser.

On goods returned for customer convenience, when the purchaser returns materials in compliance with these Terms which are accepted by ABUS, the purchaser may be issued a credit for 85% of the purchase price, with 15% charged by ABUS for handling and reprocessing.

Refused Orders – Orders refused for any reason will be charged a 15% restocking fee and all applicable freight costs incurred by ABUS will be charged to your account.

All refunds will be in the form of a merchandise credit, no cash refunds will be given.

Custom Pinning/Keying orders will be assessed a 25% re-stocking fee. All engraved locks are non-refundable.

FULL WARRANTY

This warranty gives you specific rights, and you may have other rights which vary from state to state. This warranty applies to ABUS brand products only.

If an ABUS product fails to work properly due to a manufacturing defect, return it to ABUS postage prepaid, and we will return it repaired or replaced at our discretion. To obtain warranty service, please call 800.352.2287 or simply return the padlock prepaid along with receipt of purchase and all parts and keys if applicable to:

ABUS USA LLC
23910 N. 19th Ave., #56
Phoenix, AZ 85085-1850

ABUS products are warranted for a specific period of time from date of purchase. Commercial products are warranted for 2 years against manufacturing defects and ABUS reserves the right to replace or repair the product at its discretion. ABUS will return the repaired or replaced product to the original purchaser.

All products sold under the Vitesse™ High Security Cylinder line will have a limited two (2) year warranty from the time that the original goods were transferred from the Purchaser. ABUS Vitesse™ high security keys will have a lifetime warranty against manufacturing defects and breakage.

REQUIREMENTS FOR COMBINED AND UNCOMBINED VITESSE™ PRODUCTS:

1. Keys shall be cut to the ABUS Vitesse™ specifications required for the particular keyway and depth system and be original key blanks made by ABUS.
2. All pin lengths shall be selected according to prescribed ABUS Vitesse™ requirements.
3. Original ABUS Vitesse™ brand cylinders and cylinder components, including pin tumblers and key blanks, shall be used. We reserve the right to void any warranties or claims for warranty on the basis of using products or components that are not produced by ABUS USA, LLC or its affiliated ABUS sister companies.
4. ABUS will not pay for the cost of the repair performed, reinstallation or new installation of a new or existing keying systems or products. Furthermore, ABUS cannot be held liable for any related fees, loss of use or perceived loss of use or any other associated issues in terms of a warranty claim on the ABUS Vitesse™ keying system. Written notice of a product or component part believed to be defective as covered by this warranty should be sent to ABUS and should include your name and address, an identification of the product or component part and a brief description of the defect. Upon receipt of such notice, ABUS will inform where to ship the product or component with prepaid shipping for inspection and in the event such inspection reveals a defect covered by this warranty, the product will be repaired and or replaced. ABUS and its affiliates reserve the right to replace products covered by this warranty that may be discontinued with what we deem as a suitable equivalent.

LIMITATION ON LIABILITY

To the extent permitted by law, ABUS and its agents and affiliates (collectively "ABUS Parties") shall not be responsible for, and the purchaser hereby assumes the risk of, and hereby releases ABUS for any damages or injury whatsoever (including, without limitation, incidental or consequential damages, damages for lost profits or business interruption, and punitive damages) caused by or related to any use of ABUS Products, regardless of any error, omission, interruption, defect, failure of performance, delay in operation or transmission, even if ABUS has been advised of the possibility of such damages. If, notwithstanding the foregoing limitations, ABUS has any liability to the purchaser despite the foregoing limitations, the purchaser agrees that the ABUS' total liability to the purchaser for all losses, damages, and causes of action, whether in contract, equity, tort (including without limitation, negligence and gross negligence), or otherwise, will not exceed the amount the purchaser paid to ABUS for the ABUS products. Any action or arbitration brought against the ABUS pertaining to or in connection with the ABUS Products must be commenced and served upon ABUS within one (1) year after the date the cause of action arose, and not thereafter. Failure to abide by such deadline will constitute a complete defense for the ABUS Parties to the purchaser's claims.

NO THIRD PARTY LIABILITY

If the purchaser uses the ABUS Products on behalf of others or provides to others any products referenced herein, the ABUS Parties shall have no liability to such persons whatsoever, and the purchaser agree to defend and indemnify the ABUS Parties from any and all claims and demands asserted against them, and from any legal fees, costs and other expenses that the ABUS Parties incur therewith.

GOVERNING LAW & JURISDICTION

These Terms are governed by the laws of the State of Arizona, U.S.A. but without regard to its principles of conflict of laws. For any interpretational disputes relating to, or claims arising from, these Terms, the purchaser agrees to the exclusive jurisdiction of the Superior Court of Arizona in Maricopa County, provided, however, that such restriction shall not apply to legal actions initiated or brought by ABUS. Upon request by ABUS, all disputes concerning and claims arising from the foregoing shall be referred to binding arbitration in Maricopa County, Arizona by an arbitrator selected only by the Superior Court of Arizona in Maricopa County. The purchaser hereby waives its right to a jury with regard to claims against the ABUS Parties hereunder. The language used in these Terms shall not be construed.

ABUS | USA
www.abus.com

23910 North 19th Avenue, #56
Phoenix, AZ 85085
P: 800-352-ABUS
F: 623-516-9934
customerservice@us.abus.com

FIND US @ABUSUSA!



Due to a policy of continental development, ABUS reserves the right to modify technical details & colors. E&OE ABUS © 2019



01/19 Security Catalog
Part 97501

